

Note: This Drawing is the property of Kapil Enterprises-Kundli, and must not be copied or reproduced without permission or Written authorisation by Kapil Enterprises-Kundli

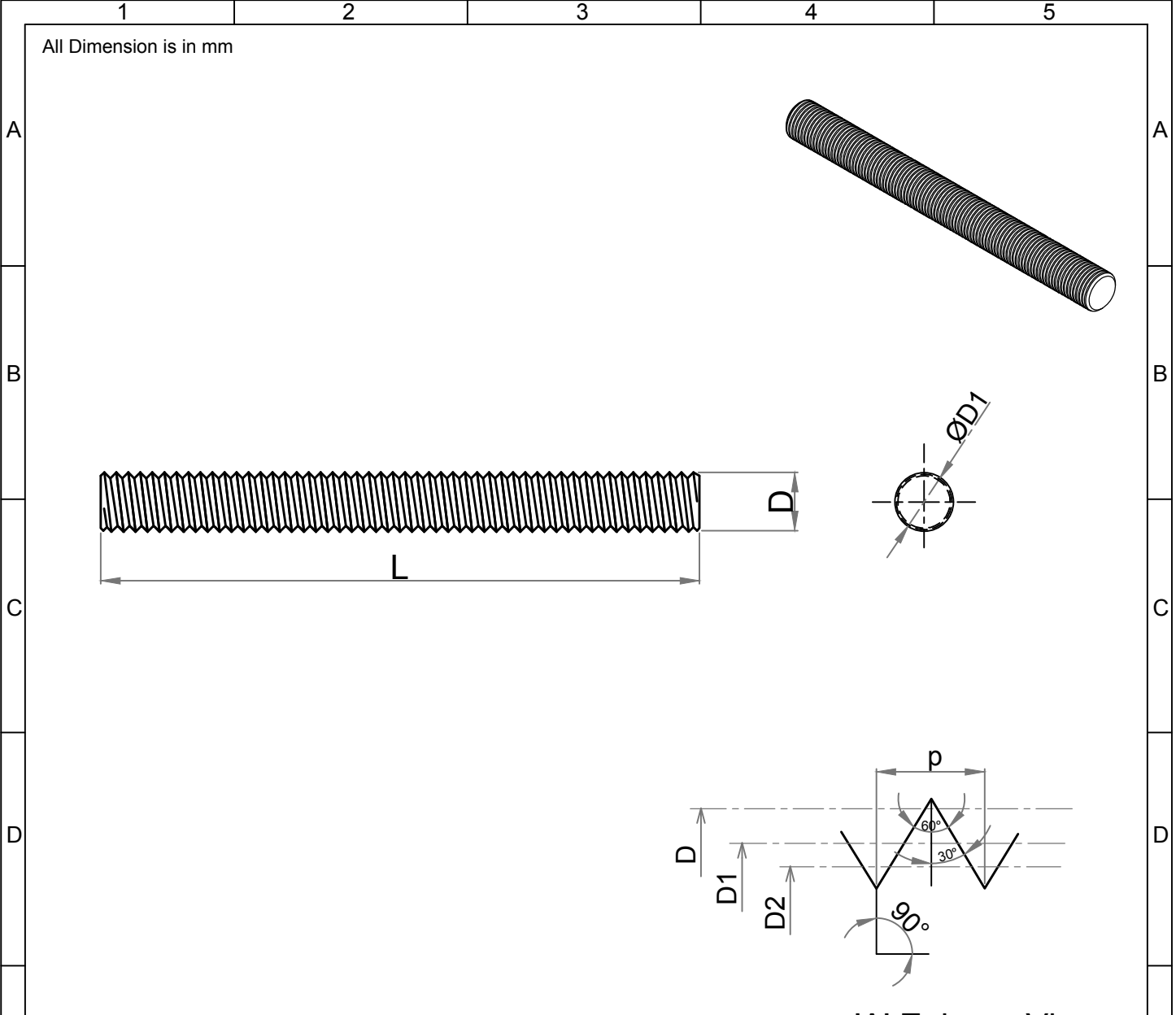

Fully Threaded Stud Bolt As per ASTM A193 1"x5"

'A' Enlarge View

Parameters	Symbol	Minimum	Maximum	Drawing No.- KE-BASE-2200-00121-B18.1.1-A193-B7M-1x5		
				Dimension as per		B18.1.1
Total Length	L	127.00	129.00	Chemical & Mechanical properties as per		ASTM A193
Threading Length	I	F.T	F.T	Grade		B7M
Major diameter	D	24.96	25.35	Title		Stud Bolt
Pitch diameter	D1	23.11	23.29	Size	1"x5"	Status- Approved
Minor diameter	D2	21.45	-	Dated	13.06.2018	Proj.
Chamfer	u	0.00	6.00	Mass/Weight	0.42706 kg/piece	
Thread per Inch	TPI	8 UNC				
Thread tolerance class	C	2A				
Amendment				Drawn By	Checked By	Approved By
Details	Revision No.	Dated	Authorised by	Pankaj Kumar (Ass. QC Manager)	Santosh Kumar (Plant Head-GM)	Kapil Aggarwal CEO-MD
					Kapil Enterprises 330 EHTP, HSIIDC, Kundli Industrial Estate Sonapat - Haryana-131028, Ph:9811009061 Email:sales@bigboltnut.com, kapil@roll-fast.com	