

Note: This Drawing is the property of Kapil Enterprises-Kundli, and must not be copied or reproduced without permission or Written authorisation by Kapil Enterprises-Kundli

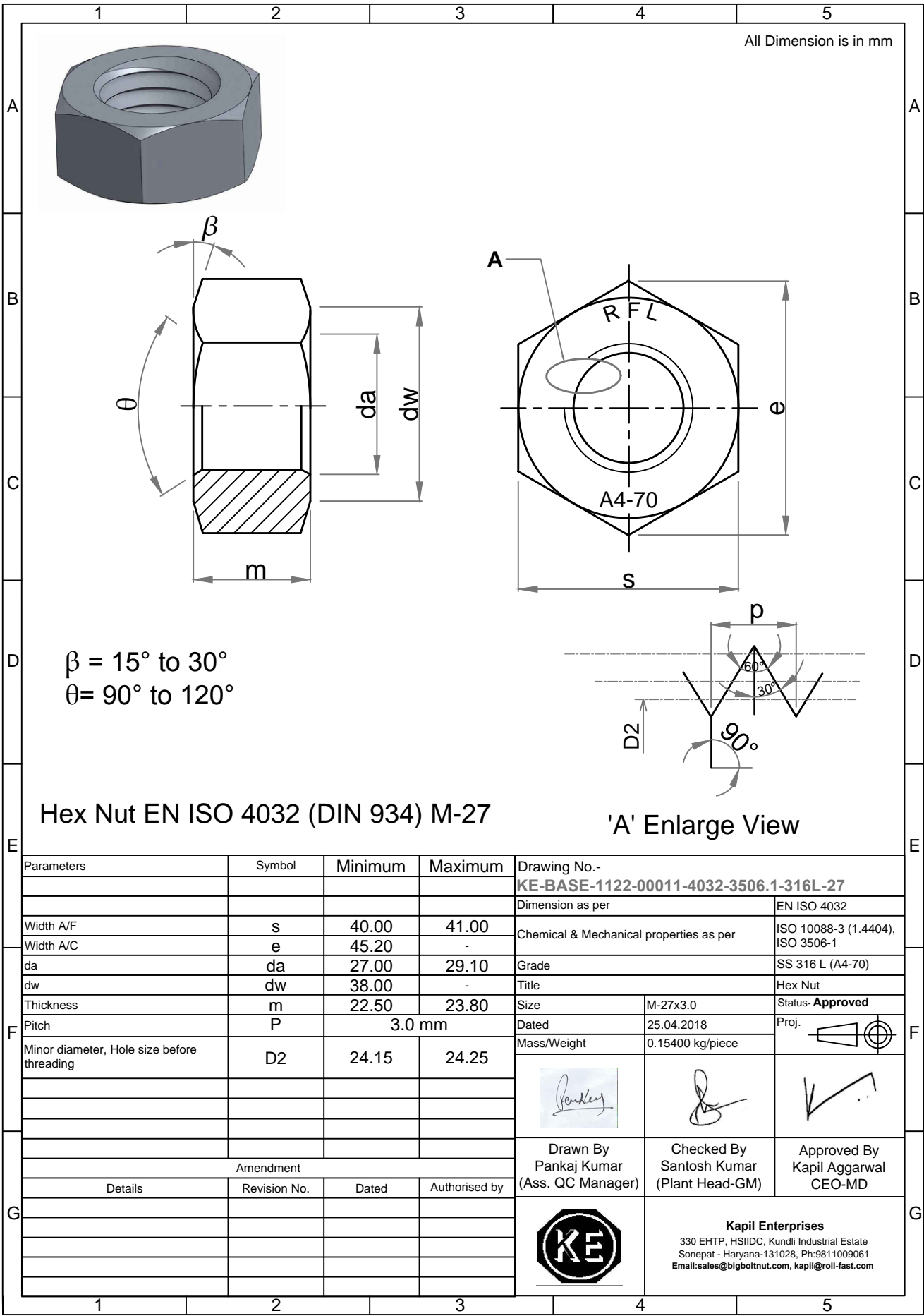

Hex Nut EN ISO 4032 (DIN 934) M-27

'A' Enlarge View

Parameters	Symbol	Minimum	Maximum
Width A/F	s	40.00	41.00
Width A/C	e	45.20	-
da	da	27.00	29.10
dw	dw	38.00	-
Thickness	m	22.50	23.80
Pitch	P	3.0 mm	
Minor diameter, Hole size before threading	D2	24.15	24.25
Amendment			
Details	Revision No.	Dated	Authorised by

Drawing No.- KE-BASE-1122-00011-4032-3506.1-316L-27		
Dimension as per		EN ISO 4032
Chemical & Mechanical properties as per		ISO 10088-3 (1.4404), ISO 3506-1
Grade		SS 316 L (A4-70)
Title		Hex Nut
Size	M-27x3.0	Status- Approved
Dated	25.04.2018	Proj.
Mass/Weight	0.15400 kg/piece	
Drawn By Pankaj Kumar (Ass. QC Manager)	Checked By Santosh Kumar (Plant Head-GM)	Approved By Kapil Aggarwal CEO-MD
Kapil Enterprises 330 EHTP, HSIIDC, Kundli Industrial Estate Sonapat - Haryana-131028, Ph:9811009061 Email:sales@bigboltnut.com, kapil@roll-fast.com		