

Note: This Drawing is the property of Kapil Enterprises-Kundli, and must not be copied or reproduced without permission or Written authorisation by Kapil Enterprises-Kundli

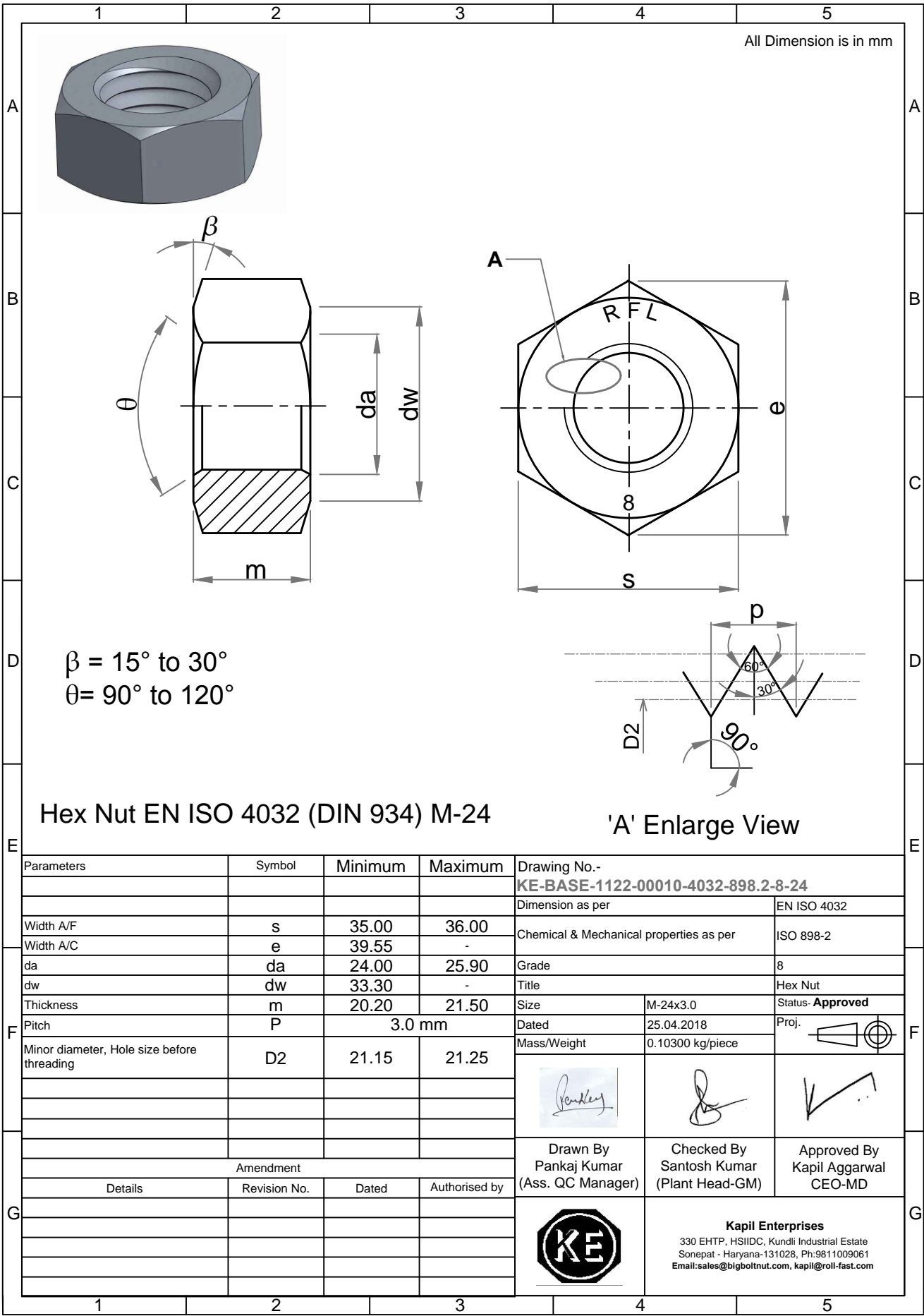



All Dimension is in mm

$\beta = 15^\circ \text{ to } 30^\circ$
 $\theta = 90^\circ \text{ to } 120^\circ$

Hex Nut EN ISO 4032 (DIN 934) M-24

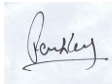
'A' Enlarge View

Parameters	Symbol	Minimum	Maximum	Drawing No.- KE-BASE-1122-00010-4032-898.2-8-24	
				Dimension as per	EN ISO 4032
Width A/F	s	35.00	36.00	Chemical & Mechanical properties as per	ISO 898-2
Width A/C	e	39.55	-	Grade	8
da	da	24.00	25.90	Title	Hex Nut
dw	dw	33.30	-	Size	M-24x3.0
Thickness	m	20.20	21.50	Status	Approved
Pitch	P	3.0 mm		Dated	25.04.2018
Minor diameter, Hole size before threading	D2	21.15	21.25	Mass/Weight	0.10300 kg/piece
Amendment				  	
Details	Revision No.	Dated	Authorised by	Drawn By Pankaj Kumar (Ass. QC Manager)	Checked By Santosh Kumar (Plant Head-GM)
					
				Kapil Enterprises 330 EHTP, HSIIDC, Kundli Industrial Estate Sonapat - Haryana-131028, Ph:9811009061 Email:sales@bigboltnut.com, kapil@roll-fast.com	