

Note: This Drawing is the property of Kapil Enterprises-Kundli, and must not be copied or reproduced without permission or Written authorisation by Kapil Enterprises-Kundli

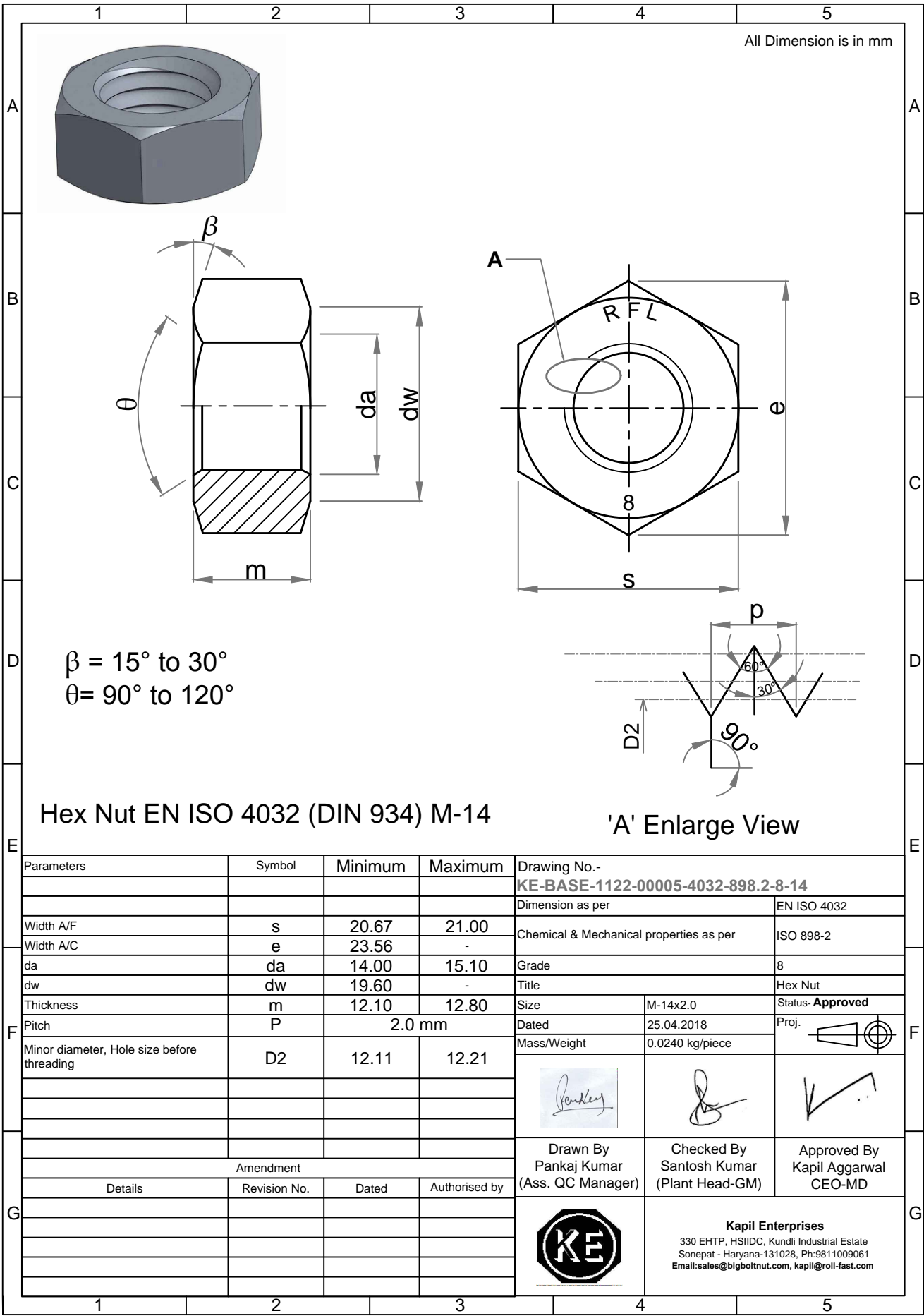

All Dimension is in mm

$\beta = 15^\circ \text{ to } 30^\circ$
 $\theta = 90^\circ \text{ to } 120^\circ$

Hex Nut EN ISO 4032 (DIN 934) M-14

'A' Enlarge View

Parameters	Symbol	Minimum	Maximum
Width A/F	s	20.67	21.00
Width A/C	e	23.56	-
da	da	14.00	15.10
dw	dw	19.60	-
Thickness	m	12.10	12.80
Pitch	P	2.0 mm	
Minor diameter, Hole size before threading	D2	12.11	12.21
Amendment			
Details	Revision No.	Dated	Authorised by

Drawing No.- KE-BASE-1122-00005-4032-898.2-8-14		
Dimension as per		EN ISO 4032
Chemical & Mechanical properties as per		ISO 898-2
Grade		8
Title		Hex Nut
Size	M-14x2.0	Status- Approved
Dated	25.04.2018	Proj.
Mass/Weight	0.0240 kg/piece	
Drawn By Pankaj Kumar (Ass. QC Manager)	Checked By Santosh Kumar (Plant Head-GM)	Approved By Kapil Aggarwal CEO-MD
Kapil Enterprises 330 EHTP, HSIIDC, Kundli Industrial Estate Sonapat - Haryana-131028, Ph:9811009061 Email:sales@bigboltnut.com, kapil@roll-fast.com		