

Note: This Drawing is the property of Kapil Enterprises-Kundli, and must not be copied or reproduced without permission or Written authorisation by Kapil Enterprises-Kundli

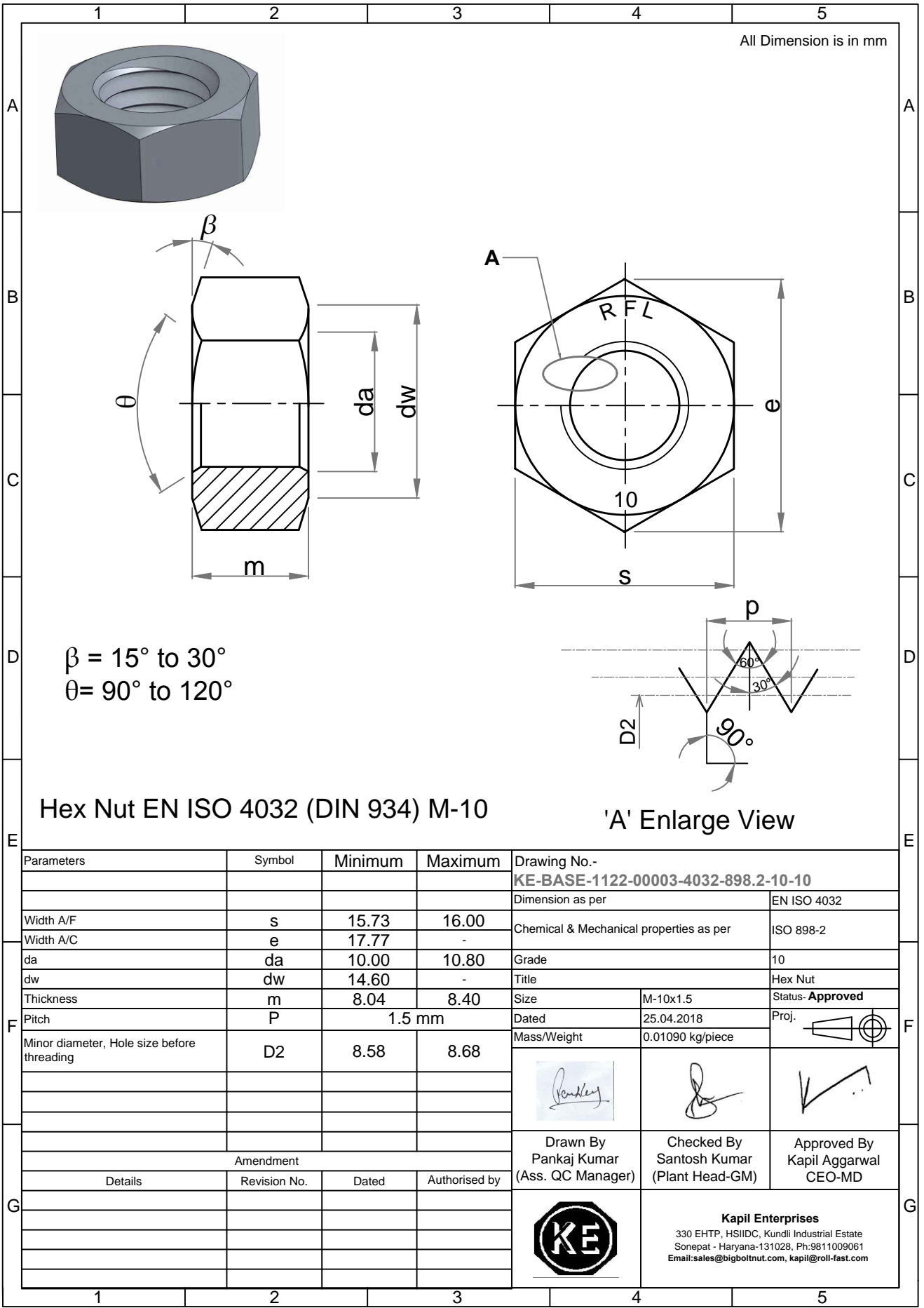

All Dimension is in mm

$\beta = 15^\circ \text{ to } 30^\circ$
 $\theta = 90^\circ \text{ to } 120^\circ$

Hex Nut EN ISO 4032 (DIN 934) M-10

'A' Enlarge View

Parameters	Symbol	Minimum	Maximum
Width A/F	s	15.73	16.00
Width A/C	e	17.77	-
da	da	10.00	10.80
dw	dw	14.60	-
Thickness	m	8.04	8.40
Pitch	P	1.5 mm	
Minor diameter, Hole size before threading	D2	8.58	8.68
Amendment			
Details	Revision No.	Dated	Authorised by

Drawing No.- KE-BASE-1122-00003-4032-898.2-10-10		
Dimension as per		EN ISO 4032
Chemical & Mechanical properties as per		ISO 898-2
Grade		10
Title		Hex Nut
Size	M-10x1.5	Status- Approved
Dated	25.04.2018	Proj.
Mass/Weight	0.01090 kg/piece	
Drawn By Pankaj Kumar (Ass. QC Manager)	Checked By Santosh Kumar (Plant Head-GM)	Approved By Kapil Aggarwal CEO-MD
Kapil Enterprises 330 EHTP, HSIIDC, Kundli Industrial Estate Sonapat - Haryana-131028, Ph:9811009061 Email:sales@bigboltnut.com, kapil@roll-fast.com		