

Note: This Drawing is the property of Kapil Enterprises-Kundli, and must not be copied or reproduced without permission or Written authorisation by Kapil Enterprises-Kundli

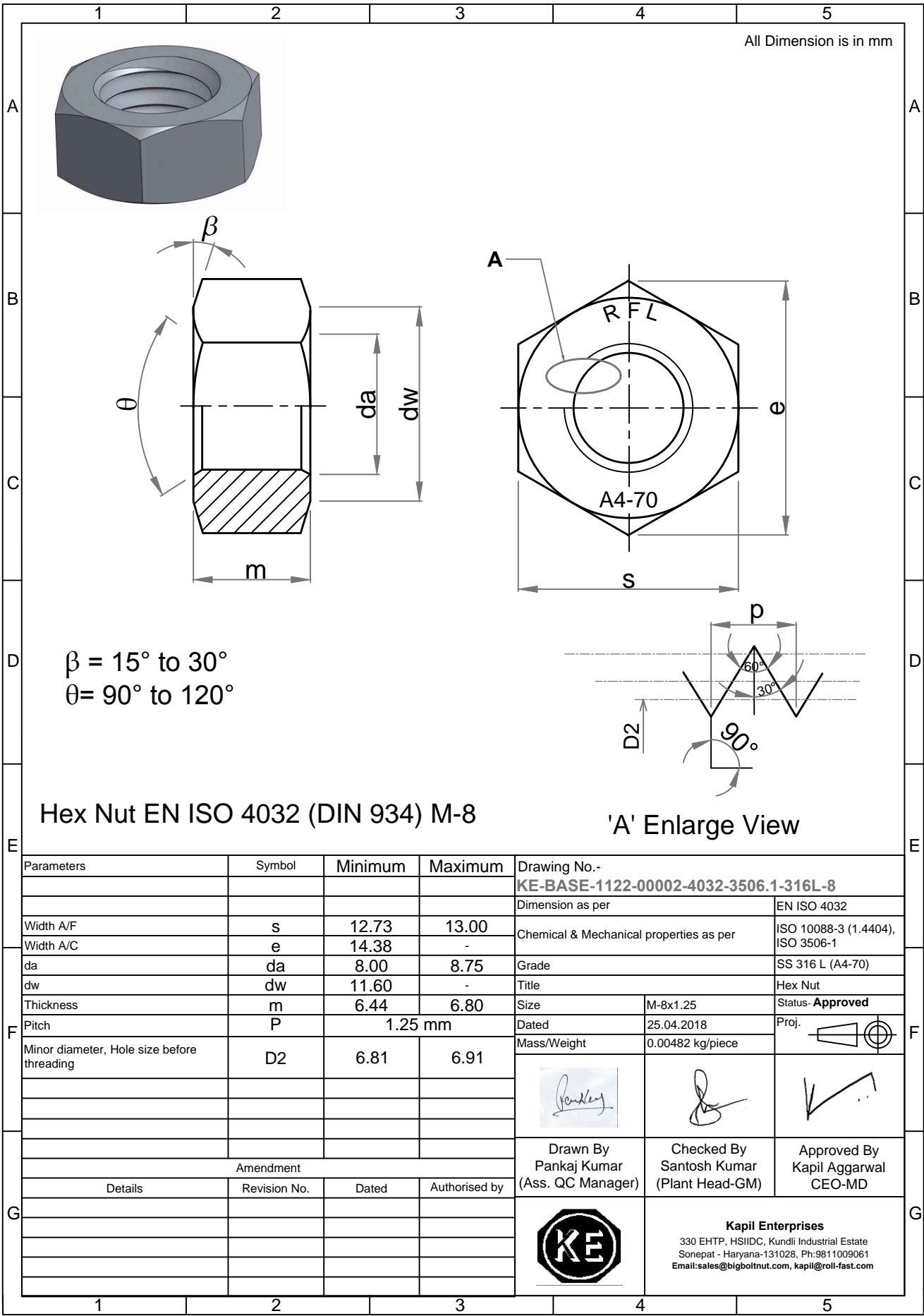

Hex Nut EN ISO 4032 (DIN 934) M-8

'A' Enlarge View

Parameters	Symbol	Minimum	Maximum
Width A/F	s	12.73	13.00
Width A/C	e	14.38	-
da	da	8.00	8.75
dw	dw	11.60	-
Thickness	m	6.44	6.80
Pitch	P	1.25 mm	
Minor diameter, Hole size before threading	D2	6.81	6.91
Amendment			
Details	Revision No.	Dated	Authorised by

Drawing No. - KE-BASE-1122-00002-4032-3506.1-316L-8

Dimension as per	EN ISO 4032	
Chemical & Mechanical properties as per	ISO 10088-3 (1.4404), ISO 3506-1	
Grade	SS 316 L (A4-70)	
Title	Hex Nut	
Size	M-8x1.25	Status- Approved
Dated	25.04.2018	Proj.
Mass/Weight	0.00482 kg/piece	
Drawn By Pankaj Kumar (Ass. QC Manager)	Checked By Santosh Kumar (Plant Head-GM)	Approved By Kapil Aggarwal CEO-MD
Kapil Enterprises 330 EHTP, HSIIDC, Kundli Industrial Estate Sonapat - Haryana-131028, Ph:9811009061 Email:sales@bigboltnut.com, kapil@roll-fast.com		