

Note: This Drawing is the property of Kapil Enterprises-Kundli, and must not be copied or reproduced without permission or Written authorisation by Kapil Enterprises-Kundli

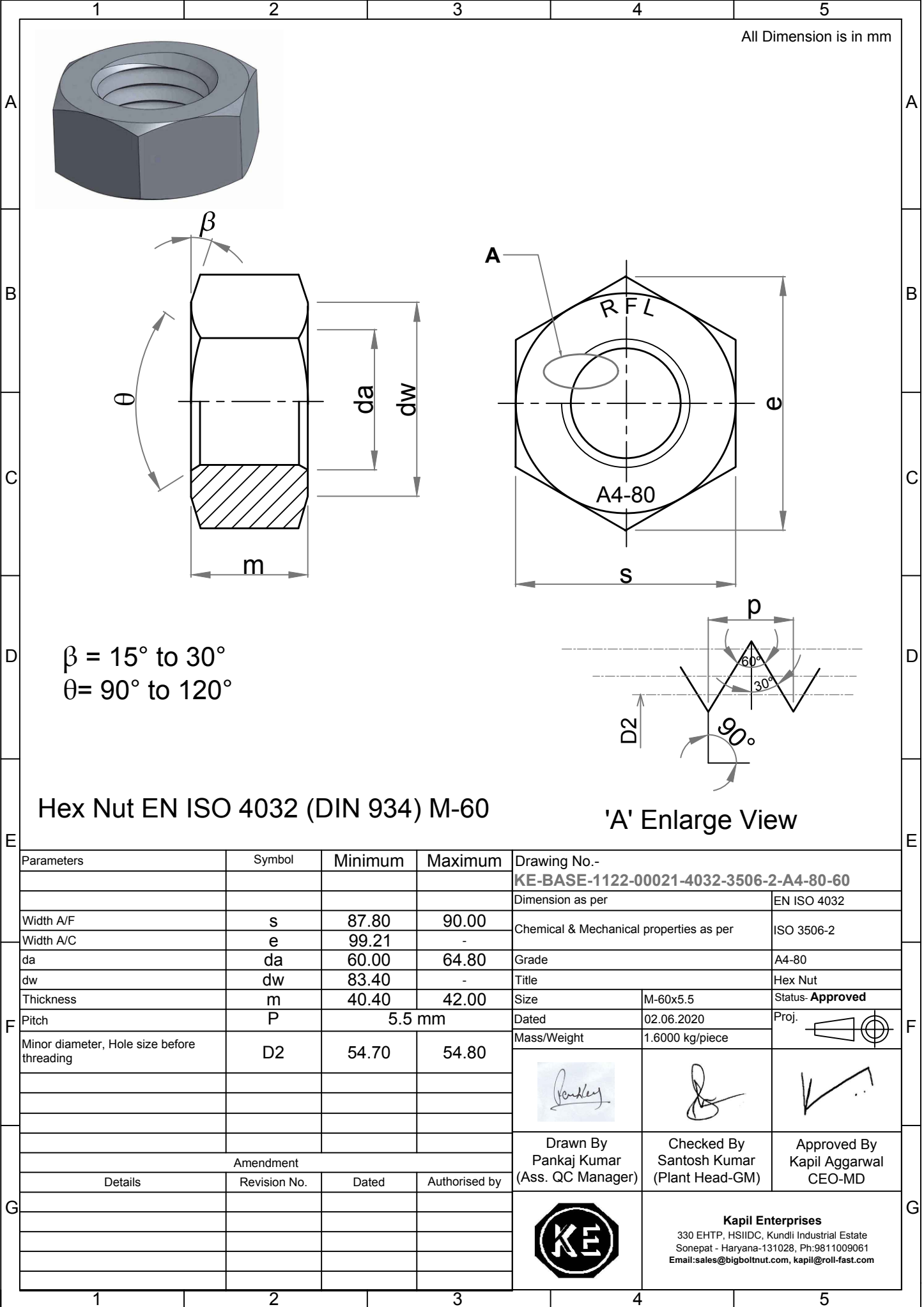

All Dimension is in mm

$\beta = 15^\circ \text{ to } 30^\circ$
 $\theta = 90^\circ \text{ to } 120^\circ$

Hex Nut EN ISO 4032 (DIN 934) M-60

'A' Enlarge View

Parameters	Symbol	Minimum	Maximum	Drawing No.- KE-BASE-1122-00021-4032-3506-2-A4-80-60	
				Dimension as per EN ISO 4032	
Width A/F	s	87.80	90.00	Chemical & Mechanical properties as per ISO 3506-2	
Width A/C	e	99.21	-	Grade A4-80	
da	da	60.00	64.80	Title Hex Nut	
dw	dw	83.40	-	Size M-60x5.5	
Thickness	m	40.40	42.00	Status- Approved	
Pitch	P	5.5 mm		Dated	02.06.2020
Minor diameter, Hole size before threading	D2	54.70	54.80	Mass/Weight	1.6000 kg/piece
				Proj.	
				Drawn By Pankaj Kumar (Ass. QC Manager) Checked By Santosh Kumar (Plant Head-GM) Approved By Kapil Aggarwal CEO-MD	
				 Kapil Enterprises 330 EHTP, HSIIDC, Kundli Industrial Estate Sonapat - Haryana-131028, Ph:9811009061 Email:sales@bigboltnut.com, kapil@roll-fast.com	
Amendment					
Details	Revision No.	Dated	Authorised by		