

Note: This Drawing is the property of Kapil Enterprises-Kundli, and must not be copied or reproduced without permission or Written authorisation by Kapil Enterprises-Kundli

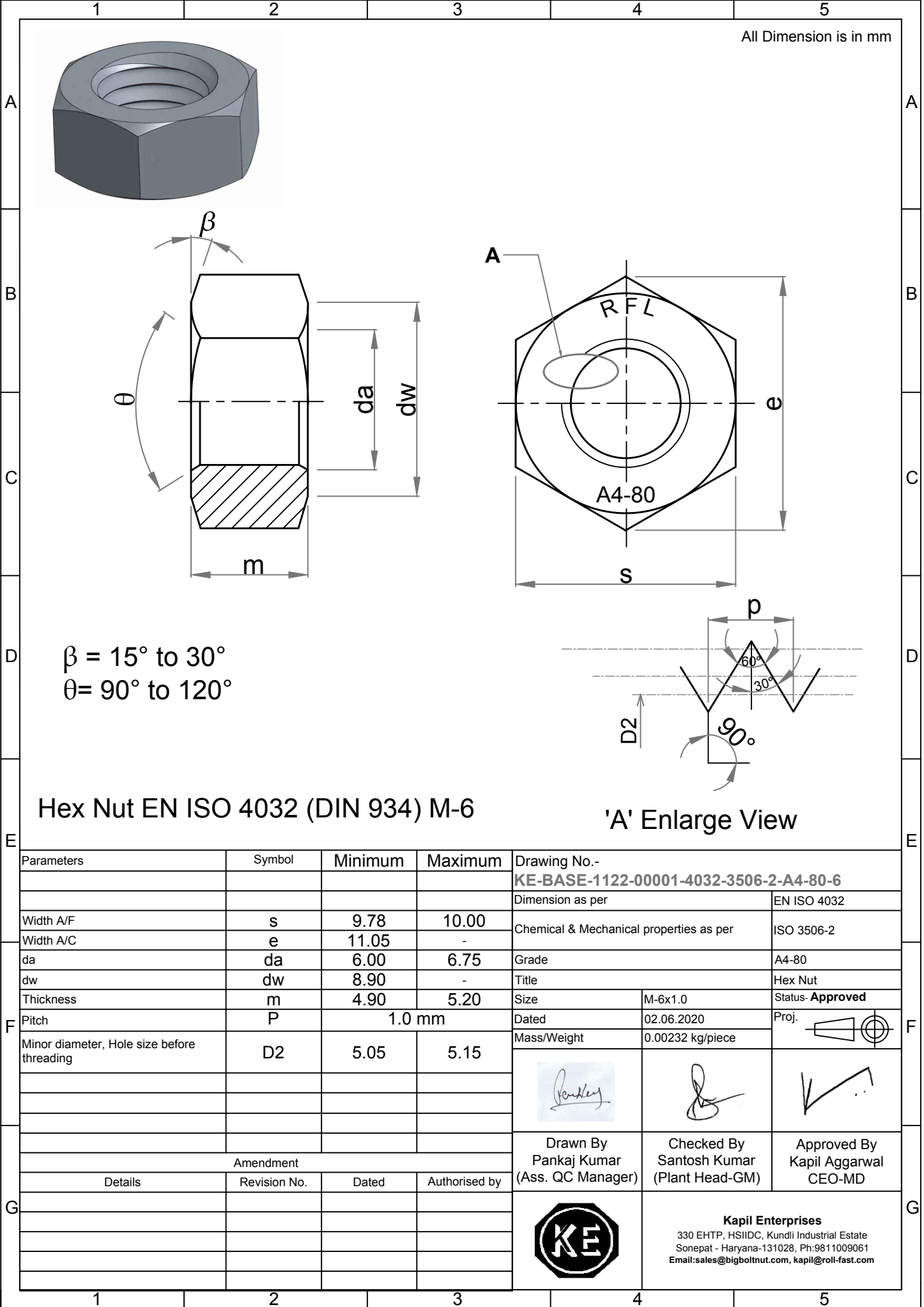

All Dimension is in mm

$\beta = 15^\circ \text{ to } 30^\circ$
 $\theta = 90^\circ \text{ to } 120^\circ$

Hex Nut EN ISO 4032 (DIN 934) M-6

'A' Enlarge View

Parameters		Symbol	Minimum	Maximum	Drawing No.- KE-BASE-1122-00001-4032-3506-2-A4-80-6	
					Dimension as per	EN ISO 4032
Width A/F		s	9.78	10.00	Chemical & Mechanical properties as per	
Width A/C		e	11.05	-	ISO 3506-2	
da		da	6.00	6.75	Grade	
dw		dw	8.90	-	A4-80	
Thickness		m	4.90	5.20	Title	
Pitch		P	1.0 mm		Hex Nut	
Minor diameter, Hole size before threading		D2	5.05	5.15	Size	M-6x1.0
					Dated	02.06.2020
					Mass/Weight	0.00232 kg/piece
					Proj.	
					Drawn By	Checked By
					Pankaj Kumar	Santosh Kumar
					(Ass. QC Manager)	(Plant Head-GM)
					Approved By	
					Kapil Aggarwal	
					CEO-MD	
					 Kapil Enterprises 330 EHTP, HSIIDC, Kundli Industrial Estate Sonapat - Haryana-131028, Ph:9811009061 Email:sales@bigboltnut.com, kapil@roll-fast.com	
Amendment						
Details	Revision No.	Dated	Authorised by			