

Note: This Drawing is the property of Kapil Enterprises-Kundli, and must not be copied or reproduced without permission or Written authorisation by Kapil Enterprises-Kundli

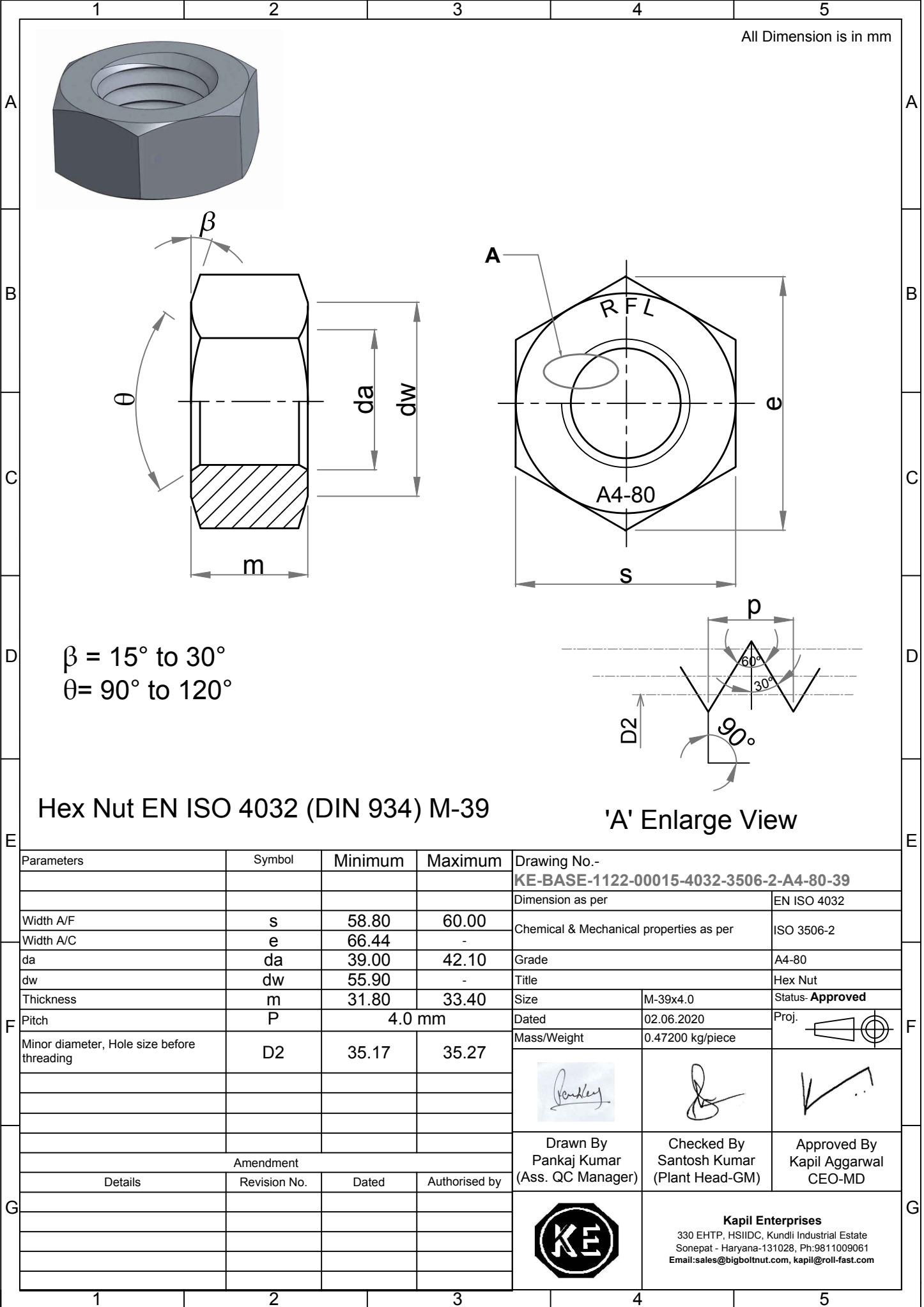

$\beta = 15^\circ \text{ to } 30^\circ$
 $\theta = 90^\circ \text{ to } 120^\circ$

Hex Nut EN ISO 4032 (DIN 934) M-39

'A' Enlarge View

Parameters	Symbol	Minimum	Maximum	Drawing No.- KE-BASE-1122-00015-4032-3506-2-A4-80-39	
				Dimension as per	EN ISO 4032
Width A/F	s	58.80	60.00	Chemical & Mechanical properties as per	ISO 3506-2
Width A/C	e	66.44	-	Grade	A4-80
da	da	39.00	42.10	Title	Hex Nut
dw	dw	55.90	-	Size	M-39x4.0
Thickness	m	31.80	33.40	Status-	Approved
Pitch	P	4.0 mm		Dated	02.06.2020
Minor diameter, Hole size before threading	D2	35.17	35.27	Mass/Weight	0.47200 kg/piece
Amendment				Drawn By	Checked By
Details	Revision No.	Dated	Authorised by	Pankaj Kumar (Ass. QC Manager)	Santosh Kumar (Plant Head-GM)
				Approved By	Kapil Aggarwal CEO-MD
					Kapil Enterprises 330 EHTP, HSIIDC, Kundli Industrial Estate Sonapat - Haryana-131028, Ph:9811009061 Email:sales@bigboltnut.com, kapil@roll-fast.com