

Note: This Drawing is the property of Kapil Enterprises-Kundli, and must not be copied or reproduced without permission or Written authorisation by Kapil Enterprises-Kundli

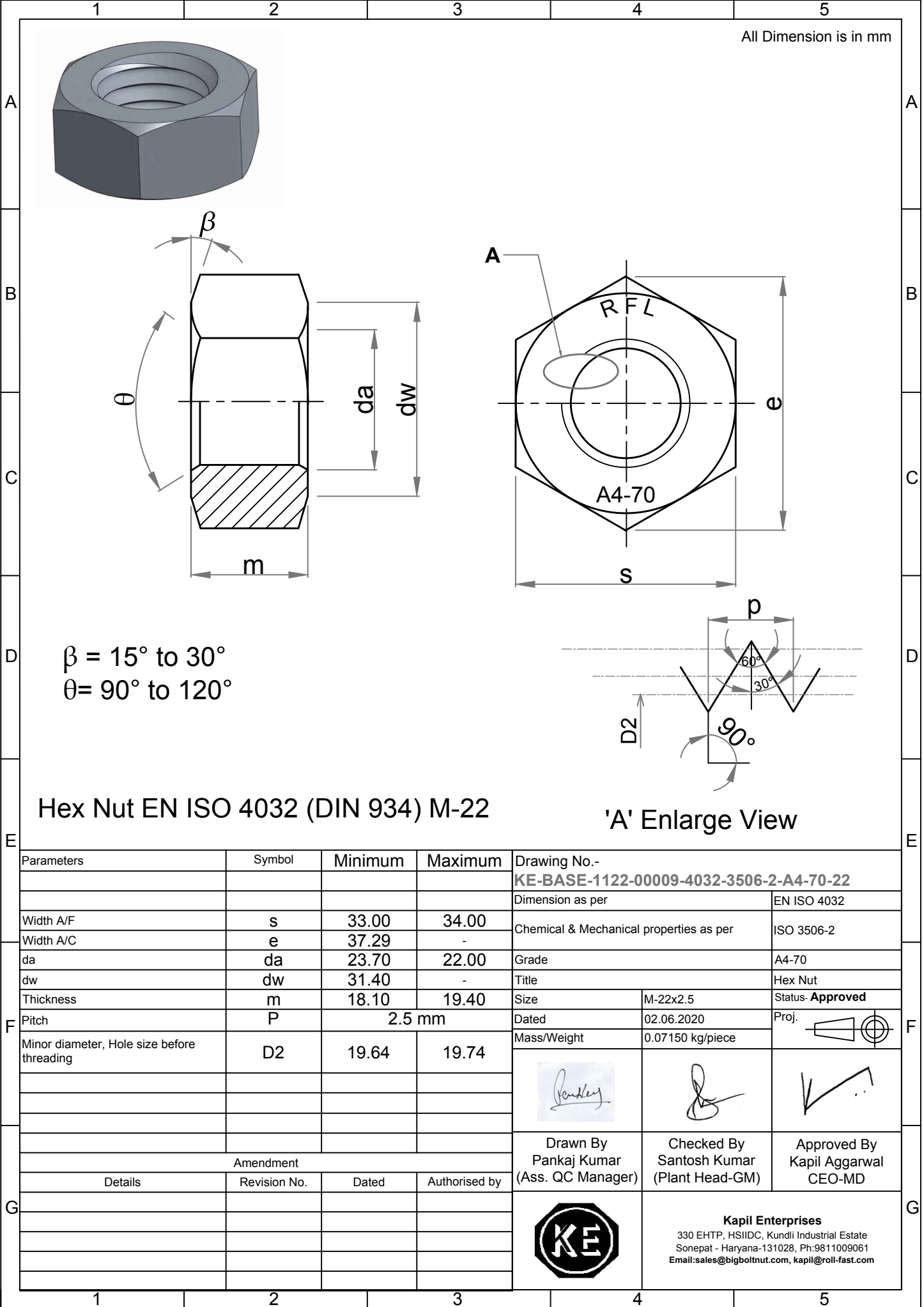

All Dimension is in mm

$\beta = 15^\circ \text{ to } 30^\circ$   
 $\theta = 90^\circ \text{ to } 120^\circ$

**Hex Nut EN ISO 4032 (DIN 934) M-22**

'A' Enlarge View

Parameters		Symbol	Minimum	Maximum	Drawing No.- <b>KE-BASE-1122-00009-4032-3506-2-A4-70-22</b>	
					Dimension as per	EN ISO 4032
Width A/F		s	33.00	34.00	Chemical & Mechanical properties as per	
Width A/C		e	37.29	-	ISO 3506-2	
da		da	23.70	22.00	Grade	
dw		dw	31.40	-	A4-70	
Thickness		m	18.10	19.40	Title	
Pitch		P	2.5 mm		Hex Nut	
Minor diameter, Hole size before threading		D2	19.64	19.74	Size	M-22x2.5
					Dated	02.06.2020
					Mass/Weight	0.07150 kg/piece
					Proj.	
					Drawn By	Checked By
					Pankaj Kumar	Santosh Kumar
					(Ass. QC Manager)	(Plant Head-GM)
					Approved By	
					Kapil Aggarwal	
					CEO-MD	
					 <b>Kapil Enterprises</b> 330 EHTP, HSIIDC, Kundli Industrial Estate Sonapat - Haryana-131028, Ph:9811009061 Email:sales@bigboltnut.com, kapil@roll-fast.com	
Amendment						
Details	Revision No.	Dated	Authorised by			