

Note: This Drawing is the property of Kapil Enterprises-Kundli, and must not be copied or reproduced without permission or Written authorisation by Kapil Enterprises-Kundli

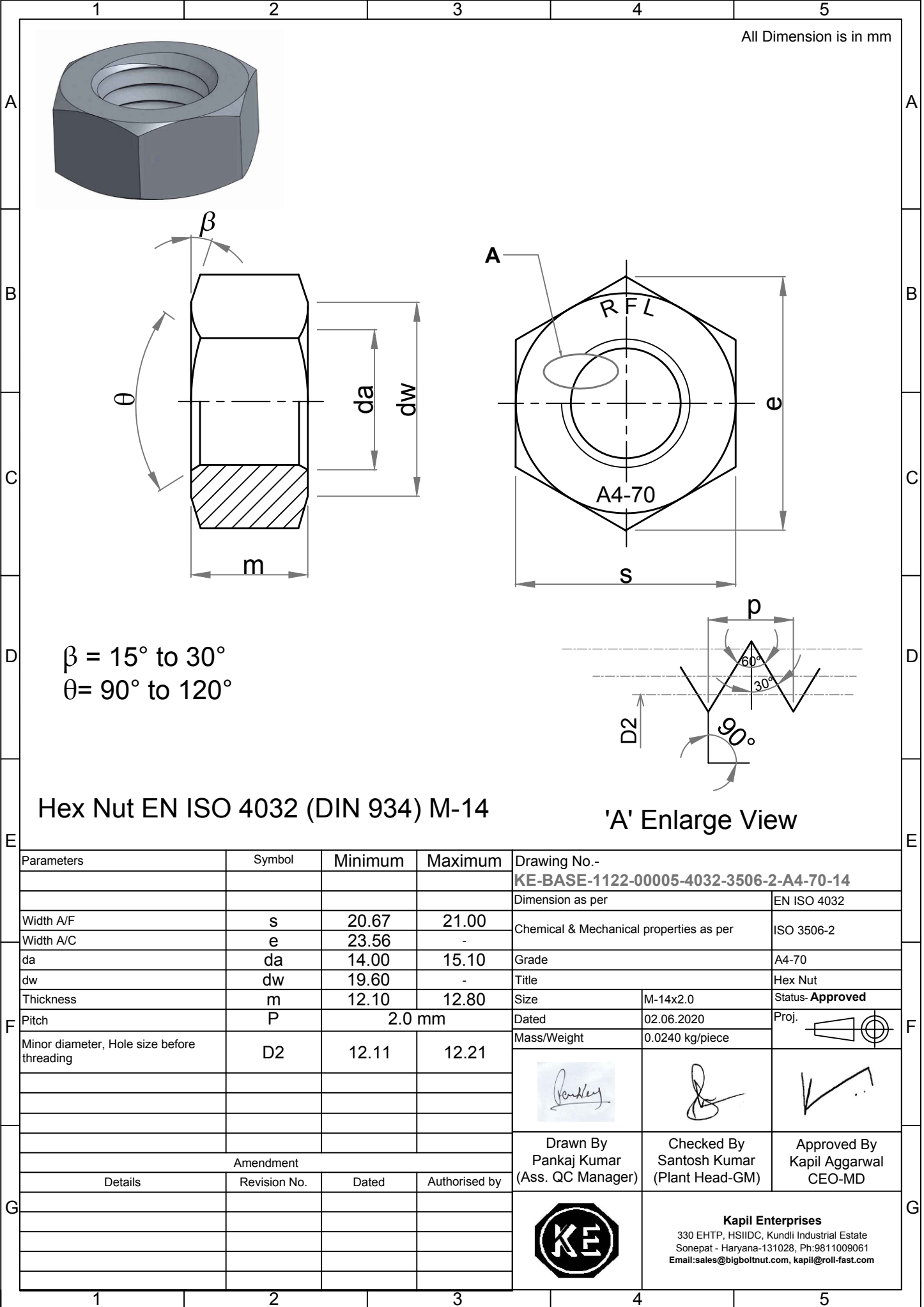

All Dimension is in mm

$\beta = 15^\circ \text{ to } 30^\circ$
 $\theta = 90^\circ \text{ to } 120^\circ$

Hex Nut EN ISO 4032 (DIN 934) M-14

'A' Enlarge View

Parameters		Symbol	Minimum	Maximum	Drawing No.- KE-BASE-1122-00005-4032-3506-2-A4-70-14	
					Dimension as per	EN ISO 4032
Width A/F		s	20.67	21.00	Chemical & Mechanical properties as per	
Width A/C		e	23.56	-	ISO 3506-2	
da		da	14.00	15.10	Grade	
dw		dw	19.60	-	A4-70	
Thickness		m	12.10	12.80	Title	
Pitch		P	2.0 mm		Hex Nut	
Minor diameter, Hole size before threading		D2	12.11	12.21	Size	M-14x2.0
					Dated	02.06.2020
					Mass/Weight	0.0240 kg/piece
					Proj.	
					Drawn By	Checked By
					Pankaj Kumar	Santosh Kumar
					(Ass. QC Manager)	(Plant Head-GM)
					Approved By	
					Kapil Aggarwal	
					CEO-MD	
					 Kapil Enterprises 330 EHTP, HSIIDC, Kundli Industrial Estate Sonapat - Haryana-131028, Ph:9811009061 Email:sales@bigboltnut.com, kapil@roll-fast.com	
Amendment						
Details	Revision No.	Dated	Authorised by			