

Note: This Drawing is the property of Kapil Enterprises-Kundli, and must not be copied or reproduced without permission or Written authorisation by Kapil Enterprises-Kundli

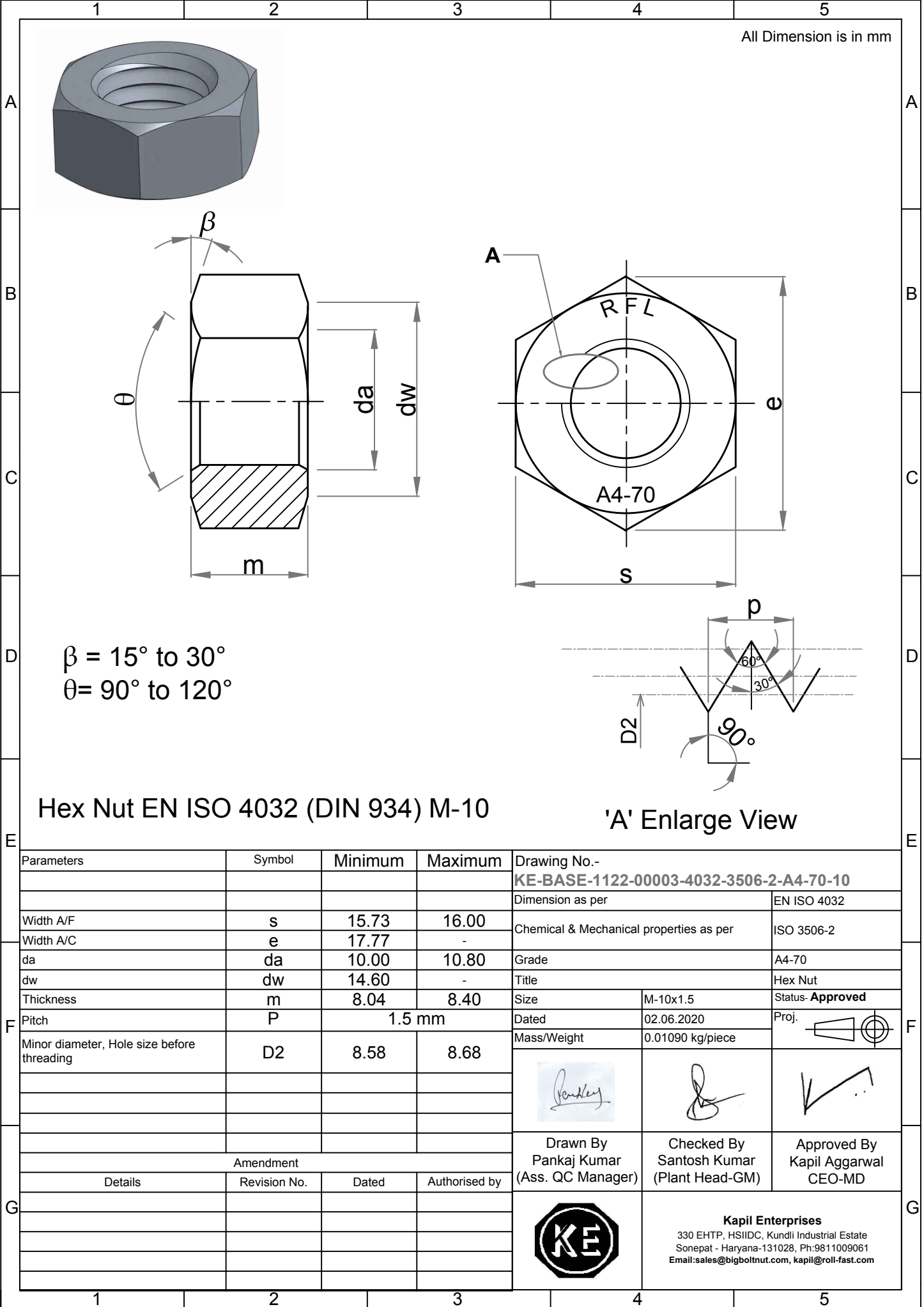

All Dimension is in mm

$\beta = 15^\circ \text{ to } 30^\circ$
 $\theta = 90^\circ \text{ to } 120^\circ$

Hex Nut EN ISO 4032 (DIN 934) M-10

'A' Enlarge View

Parameters		Symbol	Minimum	Maximum	Drawing No.- KE-BASE-1122-00003-4032-3506-2-A4-70-10		
					Dimension as per		EN ISO 4032
Width A/F		s	15.73	16.00	Chemical & Mechanical properties as per		ISO 3506-2
Width A/C		e	17.77	-	Grade		A4-70
da		da	10.00	10.80	Title		Hex Nut
dw		dw	14.60	-	Size	M-10x1.5	Status- Approved
Thickness		m	8.04	8.40	Dated	02.06.2020	Proj.
Pitch		P	1.5 mm		Mass/Weight	0.01090 kg/piece	
Minor diameter, Hole size before threading		D2	8.58	8.68	 		
Amendment							
Details		Revision No.	Dated	Authorised by	Drawn By Pankaj Kumar (Ass. QC Manager)	Checked By Santosh Kumar (Plant Head-GM)	Approved By Kapil Aggarwal CEO-MD
					 Kapil Enterprises 330 EHTP, HSIIDC, Kundli Industrial Estate Sonapat - Haryana-131028, Ph:9811009061 Email:sales@bigboltnut.com, kapil@roll-fast.com		