

Note: This Drawing is the property of Kapil Enterprises-Kundli, and must not be copied or reproduced without permission or Written authorisation by Kapil Enterprises-Kundli

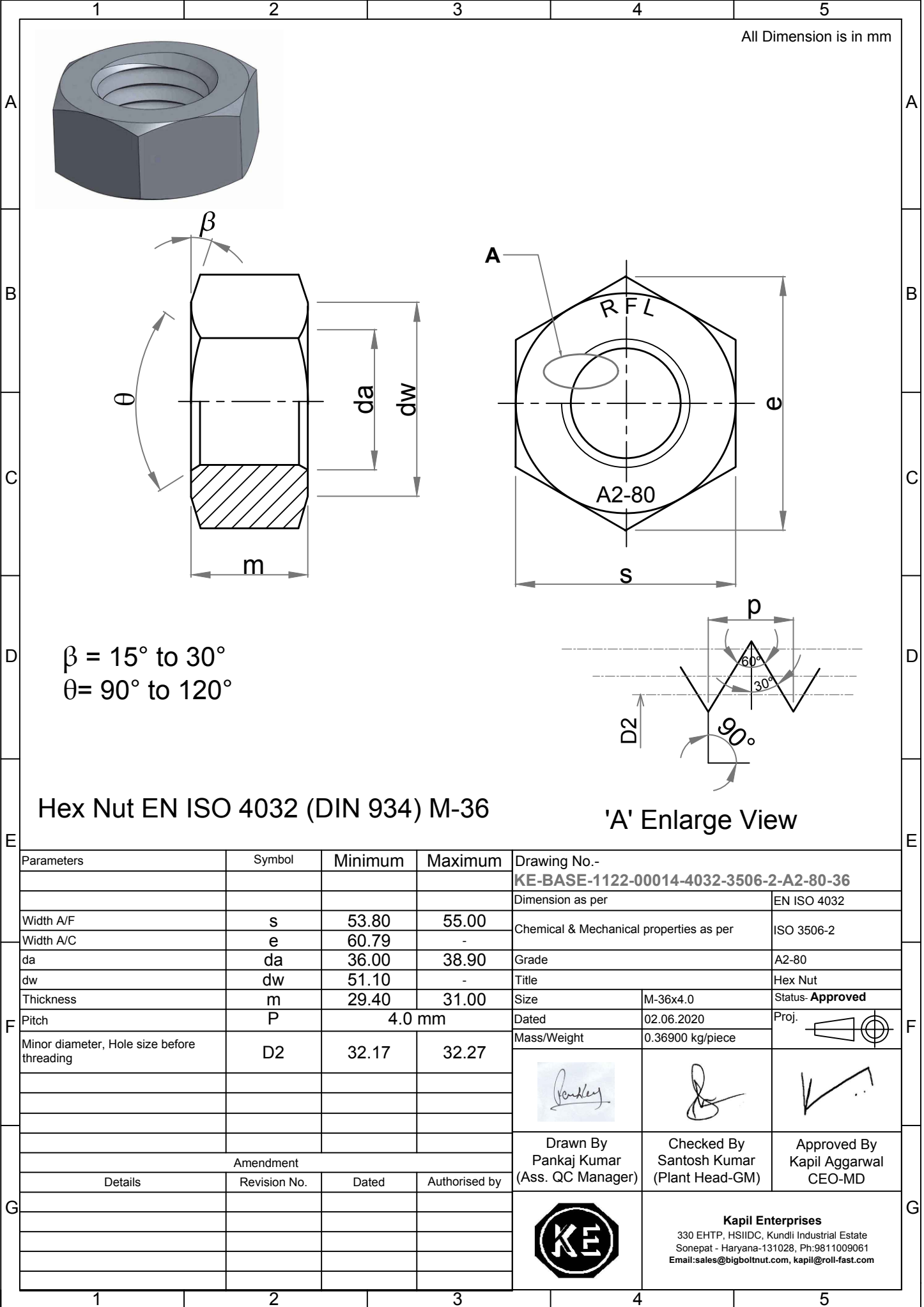

All Dimension is in mm

$\beta = 15^\circ \text{ to } 30^\circ$
 $\theta = 90^\circ \text{ to } 120^\circ$

Hex Nut EN ISO 4032 (DIN 934) M-36

'A' Enlarge View

Parameters	Symbol	Minimum	Maximum	Drawing No.- KE-BASE-1122-00014-4032-3506-2-A2-80-36	
				Dimension as per EN ISO 4032	
Width A/F	s	53.80	55.00	Chemical & Mechanical properties as per ISO 3506-2	
Width A/C	e	60.79	-	Grade A2-80	
da	da	36.00	38.90	Title Hex Nut	
dw	dw	51.10	-	Size M-36x4.0	
Thickness	m	29.40	31.00	Status- Approved	
Pitch	P	4.0 mm		Dated	02.06.2020
Minor diameter, Hole size before threading	D2	32.17	32.27	Mass/Weight	0.36900 kg/piece
				Proj.	
Amendment				Drawn By Pankaj Kumar (Ass. QC Manager) Checked By Santosh Kumar (Plant Head-GM) Approved By Kapil Aggarwal CEO-MD	
Details	Revision No.	Dated	Authorised by	 Kapil Enterprises 330 EHTP, HSIIDC, Kundli Industrial Estate Sonapat - Haryana-131028, Ph:9811009061 Email:sales@bigboltnut.com, kapil@roll-fast.com	