

Note: This Drawing is the property of Kapil Enterprises-Kundli, and must not be copied or reproduced without permission or Written authorisation by Kapil Enterprises-Kundli

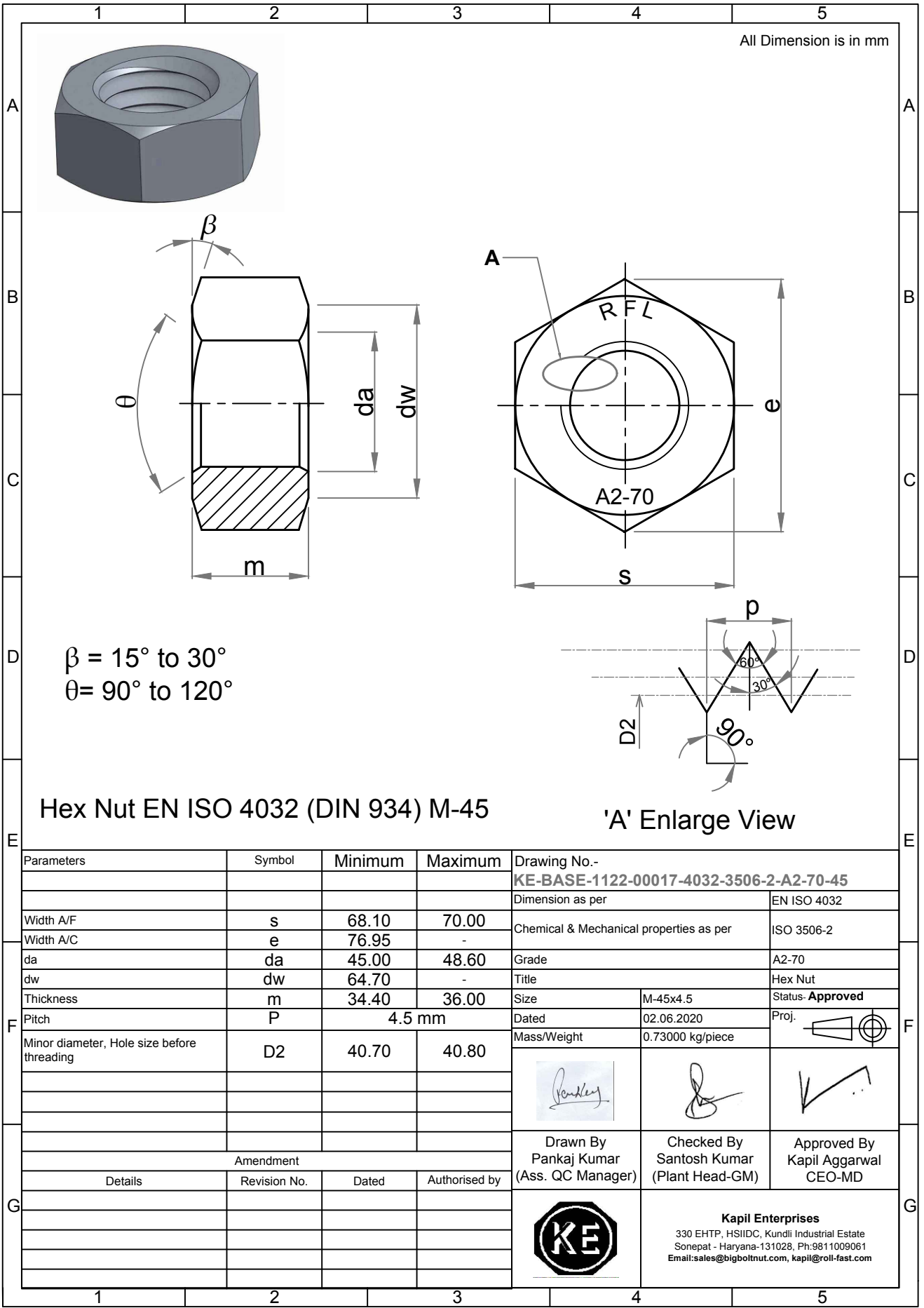

Hex Nut EN ISO 4032 (DIN 934) M-45

'A' Enlarge View

Parameters	Symbol	Minimum	Maximum	Drawing No.- KE-BASE-1122-00017-4032-3506-2-A2-70-45	
				Dimension as per	EN ISO 4032
Width A/F	s	68.10	70.00	Chemical & Mechanical properties as per	ISO 3506-2
Width A/C	e	76.95	-	Grade	A2-70
da	da	45.00	48.60	Title	Hex Nut
dw	dw	64.70	-	Size	M-45x4.5
Thickness	m	34.40	36.00	Status	Approved
Pitch	P	4.5 mm		Dated	02.06.2020
Minor diameter, Hole size before threading	D2	40.70	40.80	Mass/Weight	0.73000 kg/piece
				Proj.	
Amendment				Drawn By	Checked By
Details	Revision No.	Dated	Authorised by	Pankaj Kumar (Ass. QC Manager)	Santosh Kumar (Plant Head-GM)
				Approved By	Kapil Aggarwal CEO-MD
				Kapil Enterprises 330 EHTP, HSIIDC, Kundli Industrial Estate Sonapat - Haryana-131028, Ph:9811009061 Email:sales@bigboltnut.com, kapil@roll-fast.com	