

Note: This Drawing is the property of Kapil Enterprises-Kundli, and must not be copied or reproduced without permission or written authorisation by Kapil Enterprises-Kundli

All Dimension is in mm

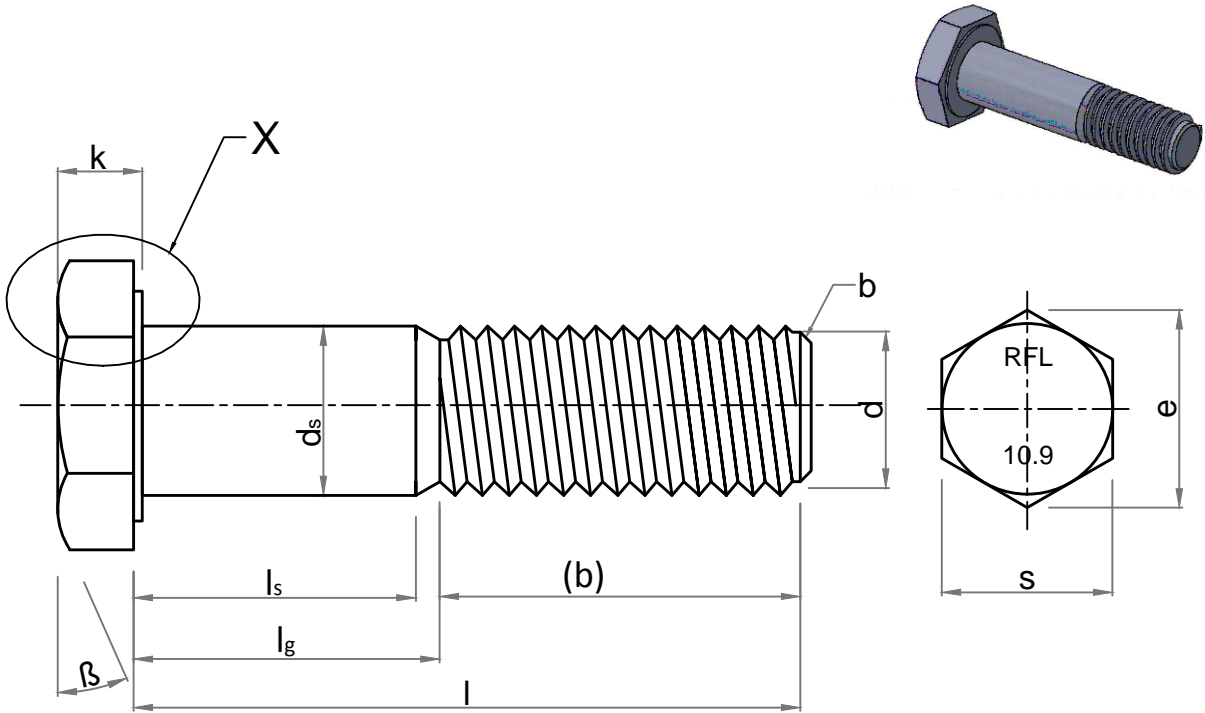

Note:

- a.  $\beta = 15^\circ$  to  $30^\circ$
- b. Point shall be chamfered on for threads  $< M4$  may be as-rolled (sheared end) in accordance with ISO 4753.
- c. Incomplete thread  $\mu < 2P$ .
- d. Reference datum for  $d_w$ .
- e. Maximum underhead fillet.



### Hex Bolt DIN EN 14399-4 M-64x180

'X' Enlarge View

Parameters	Symbol	Minimum	Maximum
Raw material diameter	D	64.50	65.50
Head thickness	k	38.75	41.25
Width A/F	s	97.80	100.00
Width A/C	e	110.50	-
Shank diameter	ds	62.80	65.20
Major diameter	D	63.32	63.92
Pitch diameter	D1	59.74	60.02
Minor diameter	D2	-	57.42
Threading length	(b)	100.00	113.00
Shank length	ls	62.00	-
Total Shank length	lg	-	80.00
Total length of bolt	l	178.00	182.00
da	da	-	73.20
dw	dw	92.90	-
Radius of fillet	r	4.00	-
c	c	0.50	1.00
Chamfer	b	0.00	12.00
Amendment			
Details	Revision No.	Dated	Authorised by

Drawing No.- <b>KE-BASE-1133-00101-14399.4-898.1-10.9-64x180</b>		
Dimension as per	DIN EN 14399-4	
Mechanical properties as per	ISO 898-1	
Grade	10.9	
Size	64x180	
Pitch	6.00	
Title	Hex Bolt	Status- <b>Approved</b>
Dated	21.04.2018	Proj.
Mass/Weight	6.837 kg/piece	
 Drawn By Pankaj Kumar (Ass. QC Manager)	 Checked By Santosh Kumar (Plant Head-GM)	 Approved By Kapil Aggarwal CEO-MD
<b>Kapil Enterprises</b> 330 EHTP, HSIIDC, Kundli Industrial Estate Sonapat - Haryana-131028, Ph:9811009061 Email:sales@bigboltnut.com, kapil@roll-fast.com		