

Note: This Drawing is the property of Kapil Enterprises-Kundli, and must not be copied or reproduced without permission or written authorisation by Kapil Enterprises-Kundli

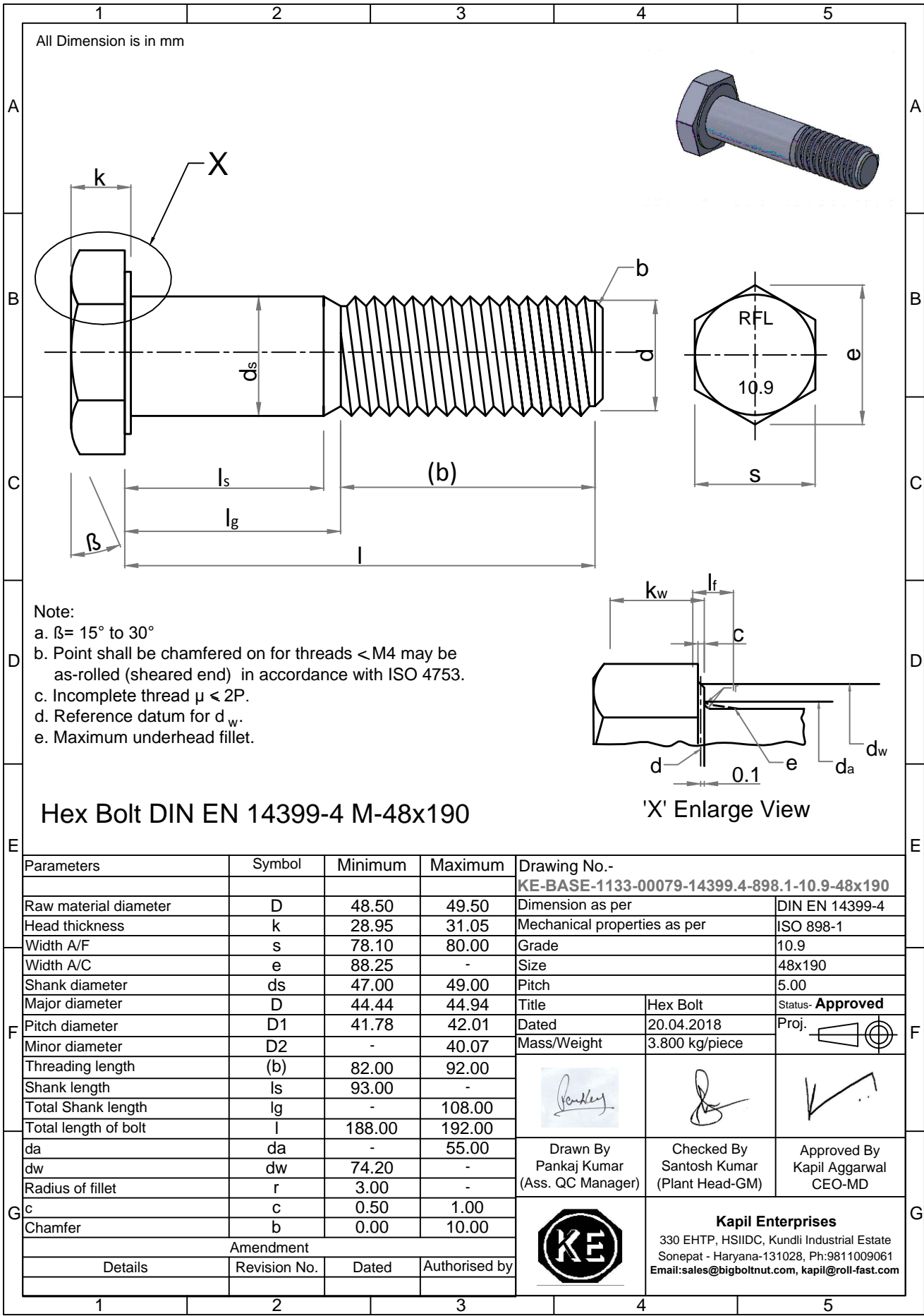

All Dimension is in mm

X

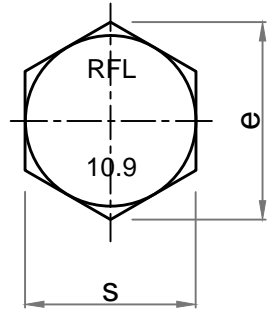
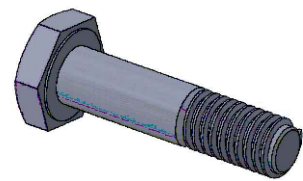
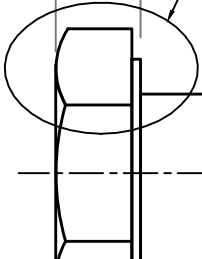



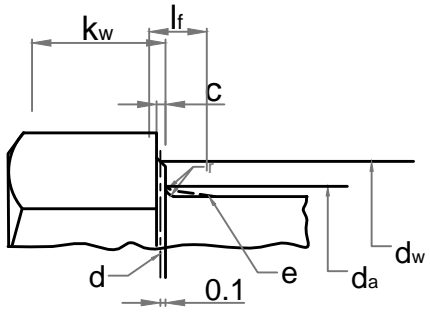

- Note:
- a. $\beta = 15^\circ$ to 30°
 - b. Point shall be chamfered on for threads < M4 may be as-rolled (sheared end) in accordance with ISO 4753.
 - c. Incomplete thread $\mu < 2P$.
 - d. Reference datum for d_w .
 - e. Maximum underhead fillet.



Hex Bolt DIN EN 14399-4 M-48x190

'X' Enlarge View

Parameters	Symbol	Minimum	Maximum	Drawing No.- KE-BASE-1133-00079-14399.4-898.1-10.9-48x190													
Raw material diameter	D	48.50	49.50	Dimension as per	DIN EN 14399-4												
Head thickness	k	28.95	31.05	Mechanical properties as per	ISO 898-1												
Width A/F	s	78.10	80.00	Grade	10.9												
Width A/C	e	88.25	-	Size	48x190												
Shank diameter	ds	47.00	49.00	Pitch	5.00												
Major diameter	D	44.44	44.94	Title	Hex Bolt												
Pitch diameter	D1	41.78	42.01	Dated	20.04.2018												
Minor diameter	D2	-	40.07	Mass/Weight	3.800 kg/piece												
Threading length	(b)	82.00	92.00	  													
Shank length	ls	93.00	-														
Total Shank length	lg	-	108.00	Drawn By	Checked By												
Total length of bolt	l	188.00	192.00	Pankaj Kumar (Ass. QC Manager)	Santosh Kumar (Plant Head-GM)												
da	da	-	55.00	Approved By	Kapil Aggarwal CEO-MD												
dw	dw	74.20	-	 <p>Kapil Enterprises 330 EHTP, HSIIDC, Kundli Industrial Estate Sonepat - Haryana-131028, Ph:9811009061 Email:sales@bigboltnut.com, kapil@roll-fast.com</p>													
Radius of fillet	r	3.00	-														
c	c	0.50	1.00	<table border="1"> <thead> <tr> <th colspan="4">Amendment</th> </tr> <tr> <th>Details</th> <th>Revision No.</th> <th>Dated</th> <th>Authorised by</th> </tr> </thead> <tbody> <tr> <td> </td> <td> </td> <td> </td> <td> </td> </tr> </tbody> </table>		Amendment				Details	Revision No.	Dated	Authorised by				
Amendment																	
Details	Revision No.	Dated	Authorised by														
Chamfer	b	0.00	10.00														