

Note: This Drawing is the property of Kapil Enterprises-Kundli, and must not be copied or reproduced without permission or written authorisation by Kapil Enterprises-Kundli

All Dimension is in mm

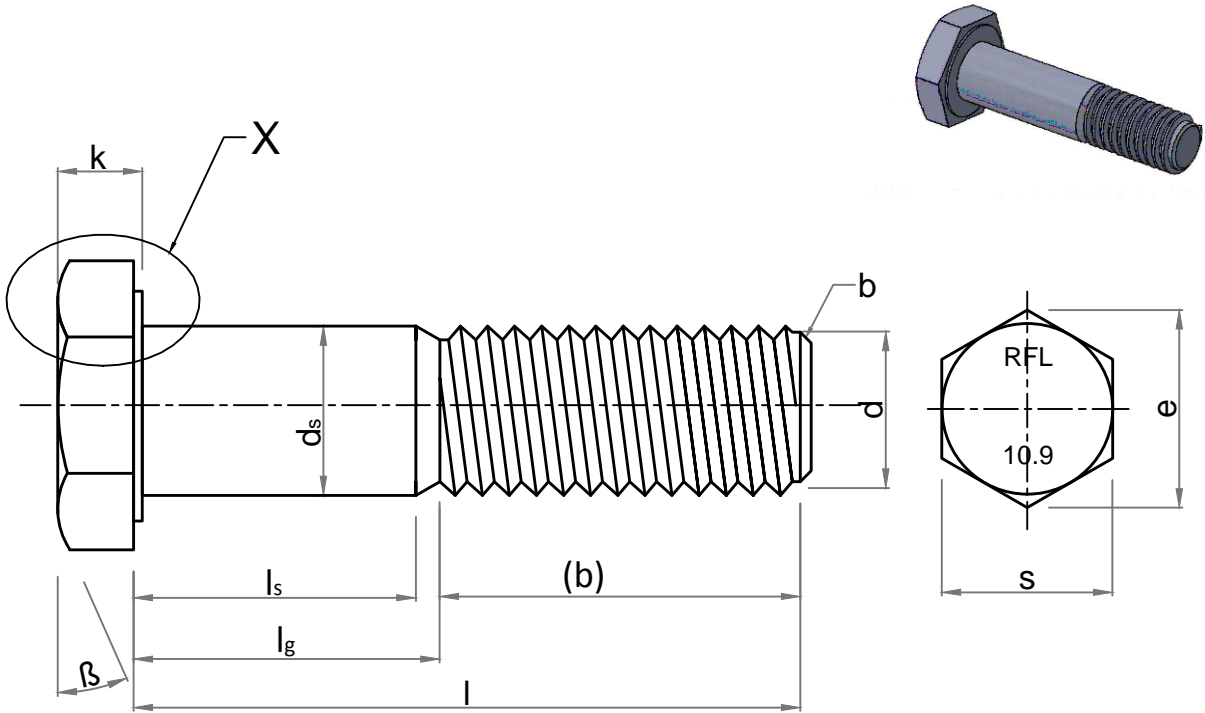

Note:

- a. $\beta = 15^\circ$ to 30°
- b. Point shall be chamfered on for threads $< M4$ may be as-rolled (sheared end) in accordance with ISO 4753.
- c. Incomplete thread $\mu < 2P$.
- d. Reference datum for d_w .
- e. Maximum underhead fillet.



Hex Bolt DIN EN 14399-4 M-45x220

'X' Enlarge View

Parameters	Symbol	Minimum	Maximum
Raw material diameter	D	45.50	46.50
Head thickness	k	26.95	29.05
Width A/F	s	73.10	75.00
Width A/C	e	82.60	-
Shank diameter	ds	44.00	46.00
Major diameter	D	44.44	44.94
Pitch diameter	D1	41.78	42.01
Minor diameter	D2	-	40.07
Threading length	(b)	76.00	84.50
Shank length	ls	130.50	-
Total Shank length	lg	-	144.00
Total length of bolt	l	217.70	222.30
da	da	-	52.00
dw	dw	69.45	-
Radius of fillet	r	3.00	-
c	c	0.50	1.00
Chamfer	b	0.00	9.00
Amendment			
Details	Revision No.	Dated	Authorised by

Drawing No.- KE-BASE-1133-00069-14399.4-898.1-10.9-45x220		
Dimension as per	DIN EN 14399-4	
Mechanical properties as per	ISO 898-1	
Grade	10.9	
Size	45x220	
Pitch	4.50	
Title	Hex Bolt	Status- Approved
Dated	18.04.2018	Proj.
Mass/Weight	3.635 kg/piece	
 Drawn By Pankaj Kumar (Ass. QC Manager)	 Checked By Santosh Kumar (Plant Head-GM)	 Approved By Kapil Aggarwal CEO-MD
Kapil Enterprises 330 EHTP, HSIIDC, Kundli Industrial Estate Sonapat - Haryana-131028, Ph:9811009061 Email:sales@bigboltnut.com, kapil@roll-fast.com		