

Note: This Drawing is the property of Kapil Enterprises-Kundli, and must not be copied or reproduced without permission or Written authorisation by Kapil Enterprises-Kundli

All Dimension is in mm

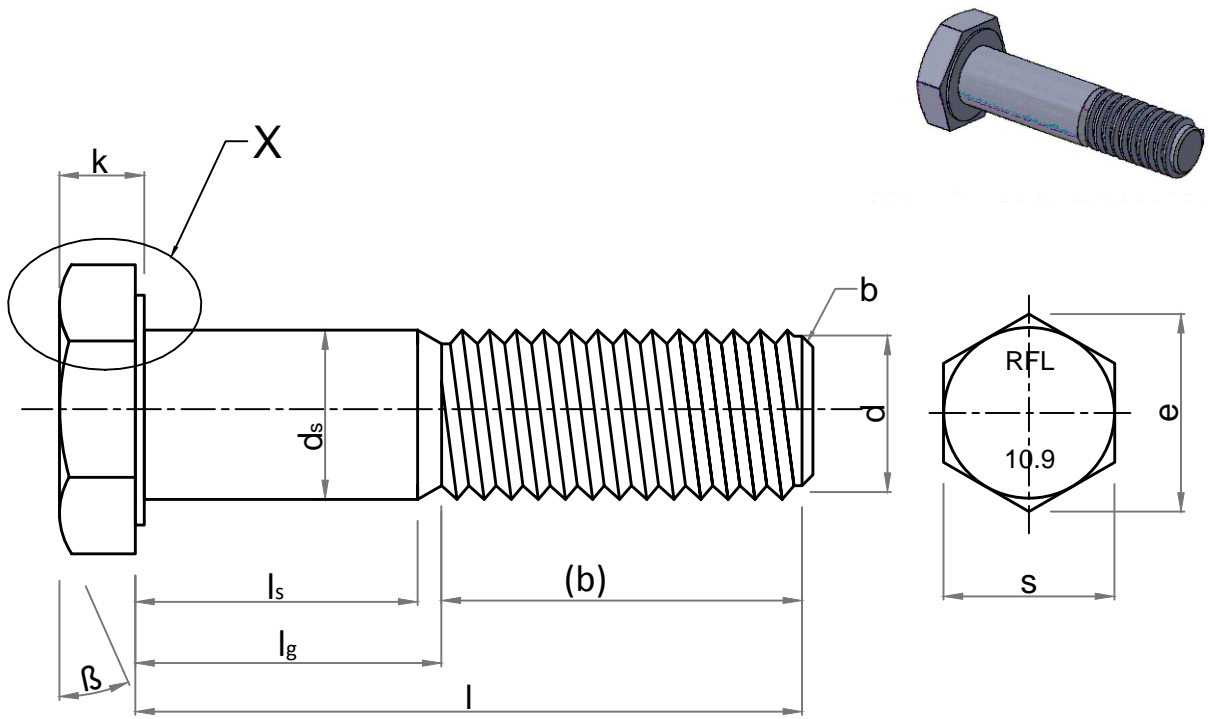

- Note:
- a. $\beta = 15^\circ$ to 30°
 - b. Point shall be chamfered on for threads $< M4$ may be as-rolled (sheared end) in accordance with ISO 4753.
 - c. Incomplete thread $\mu < 2P$.
 - d. Reference datum for d_w .
 - e. Maximum underhead fillet.

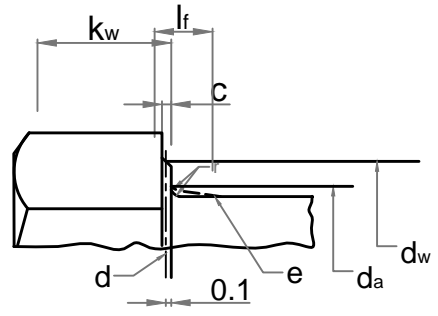

Hex Bolt DIN EN 14399-4 M-42x190

'X' Enlarge View

Parameters	Symbol	Minimum	Maximum
Raw material diameter	D	42.50	43.50
Head thickness	k	24.95	27.05
Width A/F	s	68.10	70.00
Width A/C	e	76.95	-
Shank diameter	ds	41.00	43.00
Major diameter	D	41.44	41.94
Pitch diameter	D1	38.78	39.01
Minor diameter	D2	-	37.07
Threading length	(b)	74.00	82.50
Shank length	ls	102.50	-
Total Shank length	lg	-	116.00
Total length of bolt	l	188.00	192.00
da	da	-	48.00
dw	dw	64.70	-
Radius of fillet	r	2.50	-
c	c	0.50	1.00
Chamfer	b	0.00	9.00
Amendment			
Details	Revision No.	Dated	Authorised by

Drawing No.- **KE-BASE-1133-00054-14399.4-898.1-10.9-42x190**

Dimension as per	DIN EN 14399-4	
Mechanical properties as per	ISO 898-1	
Grade	10.9	
Size	42x190	
Pitch	4.50	
Title	Hex Bolt	Status- Approved
Dated	18.04.2018	Proj.
Mass/Weight	2.768 kg/piece	
Drawn By Pankaj Kumar (Ass. QC Manager)	Checked By Santosh Kumar (Plant Head-GM)	Approved By Kapil Aggarwal CEO-MD

Kapil Enterprises
330 EHTP, HSIIDC, Kundli Industrial Estate
Sonepat - Haryana-131028, Ph:9811009061
Email:sales@bigboltnut.com, kapil@roll-fast.com