

Note: This Drawing is the property of Kapil Enterprises-Kundli, and must not be copied or reproduced without permission or written authorisation by Kapil Enterprises-Kundli

All Dimension is in mm

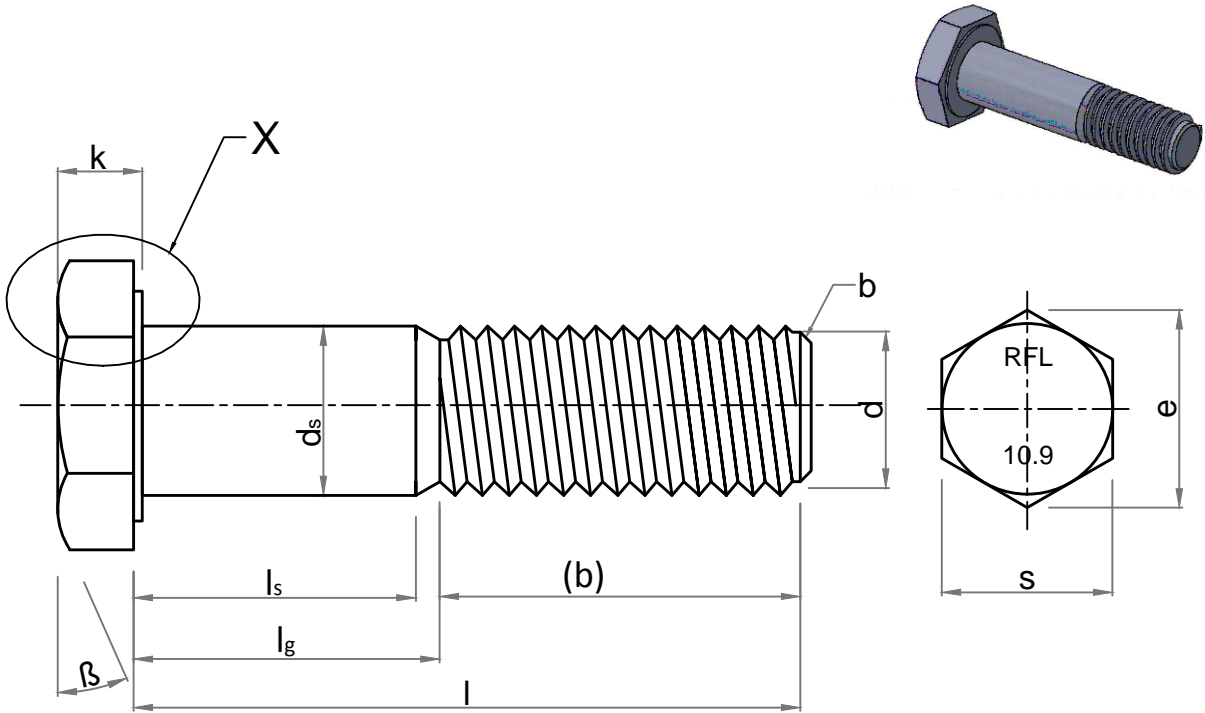

Note:

- a. $\beta = 15^\circ$ to 30°
- b. Point shall be chamfered on for threads $< M4$ may be as-rolled (sheared end) in accordance with ISO 4753.
- c. Incomplete thread $\mu < 2P$.
- d. Reference datum for d_w .
- e. Maximum underhead fillet.



Hex Bolt DIN EN 14399-4 M-39x140

'X' Enlarge View

Parameters	Symbol	Minimum	Maximum
Raw material diameter	D	39.50	40.50
Head thickness	k	23.95	26.05
Width A/F	s	63.10	65.00
Width A/C	e	71.30	-
Shank diameter	ds	38.00	40.00
Major diameter	D	38.46	38.94
Pitch diameter	D1	36.12	36.34
Minor diameter	D2	-	34.61
Threading length	(b)	68.00	75.00
Shank length	ls	60.00	-
Total Shank length	lg	-	72.00
Total length of bolt	l	138.00	142.00
da	da	-	45.00
dw	dw	60.00	-
Radius of fillet	r	2.50	-
c	c	0.50	1.00
Chamfer	b	0.00	8.00
Amendment			
Details	Revision No.	Dated	Authorised by

Drawing No.- KE-BASE-1133-00036-14399.4-898.1-10.9-39x140		
Dimension as per	DIN EN 14399-4	
Mechanical properties as per	ISO 898-1	
Grade	10.9	
Size	39x140	
Pitch	4.00	
Title	Hex Bolt	Status- Approved
Dated	17.04.2018	Proj.
Mass/Weight	1.893 kg/piece	
 Drawn By Pankaj Kumar (Ass. QC Manager)	 Checked By Santosh Kumar (Plant Head-GM)	 Approved By Kapil Aggarwal CEO-MD
Kapil Enterprises 330 EHTP, HSIIDC, Kundli Industrial Estate Sonapat - Haryana-131028, Ph:9811009061 Email:sales@bigboltnut.com, kapil@roll-fast.com		