

Note: This Drawing is the property of Kapil Enterprises-Kundli, and must not be copied or reproduced without permission or Written authorisation by Kapil Enterprises-Kundli

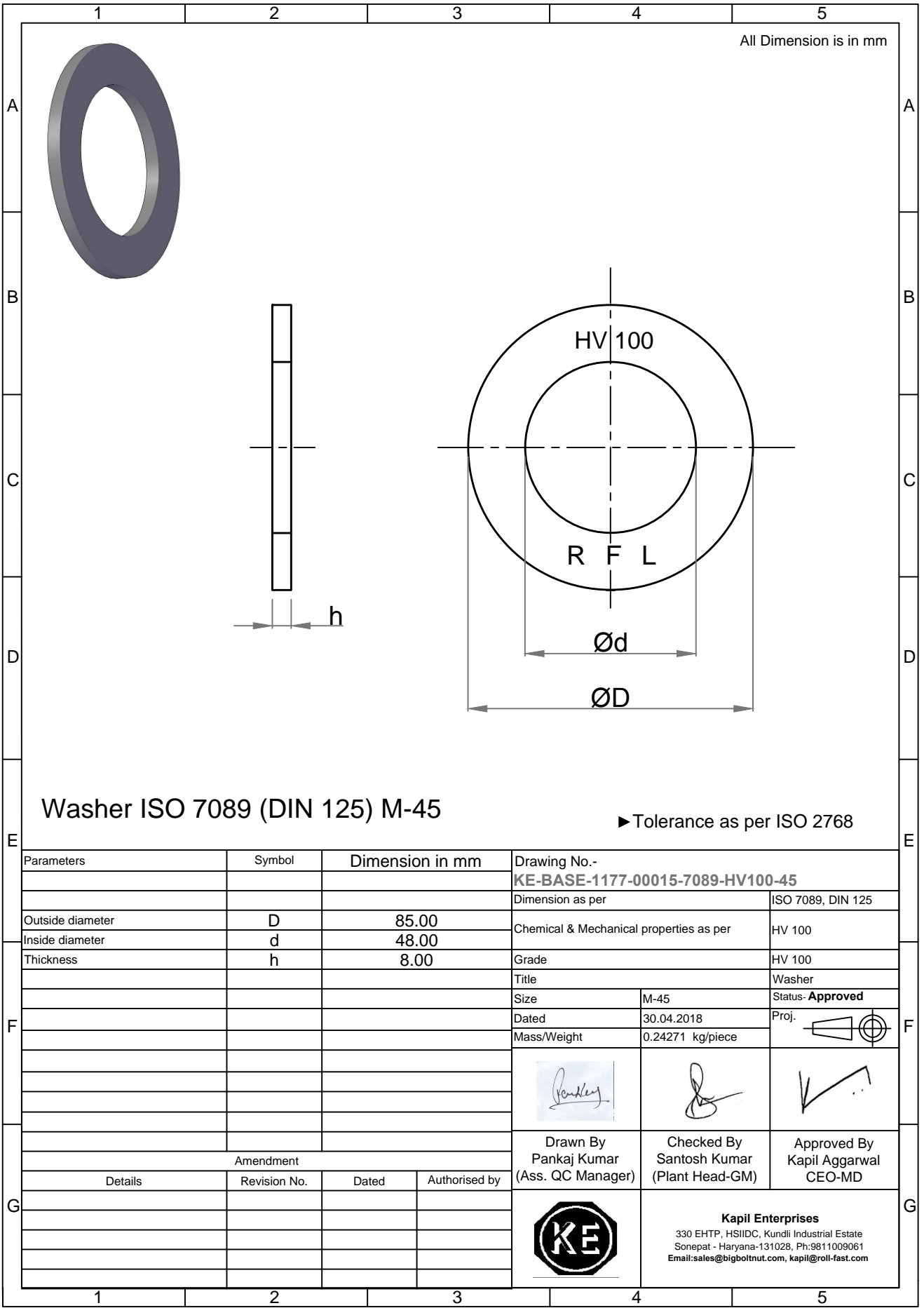

All Dimension is in mm

Washer ISO 7089 (DIN 125) M-45

► Tolerance as per ISO 2768

Parameters		Symbol		Dimension in mm		Drawing No.-	
						KE-BASE-1177-00015-7089-HV100-45	
						Dimension as per	
						ISO 7089, DIN 125	
Outside diameter		D		85.00		Chemical & Mechanical properties as per	
Inside diameter		d		48.00		HV 100	
Thickness		h		8.00		Grade	
						HV 100	
						Title	
						Washer	
						Size	
						M-45	
						Status- Approved	
						Dated	
						30.04.2018	
						Proj.	
						Drawn By Pankaj Kumar (Ass. QC Manager)	
						Checked By Santosh Kumar (Plant Head-GM)	
						Approved By Kapil Aggarwal CEO-MD	
						Kapil Enterprises 330 EHTP, HSIIDC, Kundli Industrial Estate Sonapat - Haryana-131028, Ph:9811009061 Email:sales@bigboltnut.com, kapil@roll-fast.com	
Amendment		Revision No.		Dated		Authorised by	
Details							