

Note: This Drawing is the property of Kapil Enterprises-Kundli, and must not be copied or reproduced without permission or Written authorisation by Kapil Enterprises-Kundli

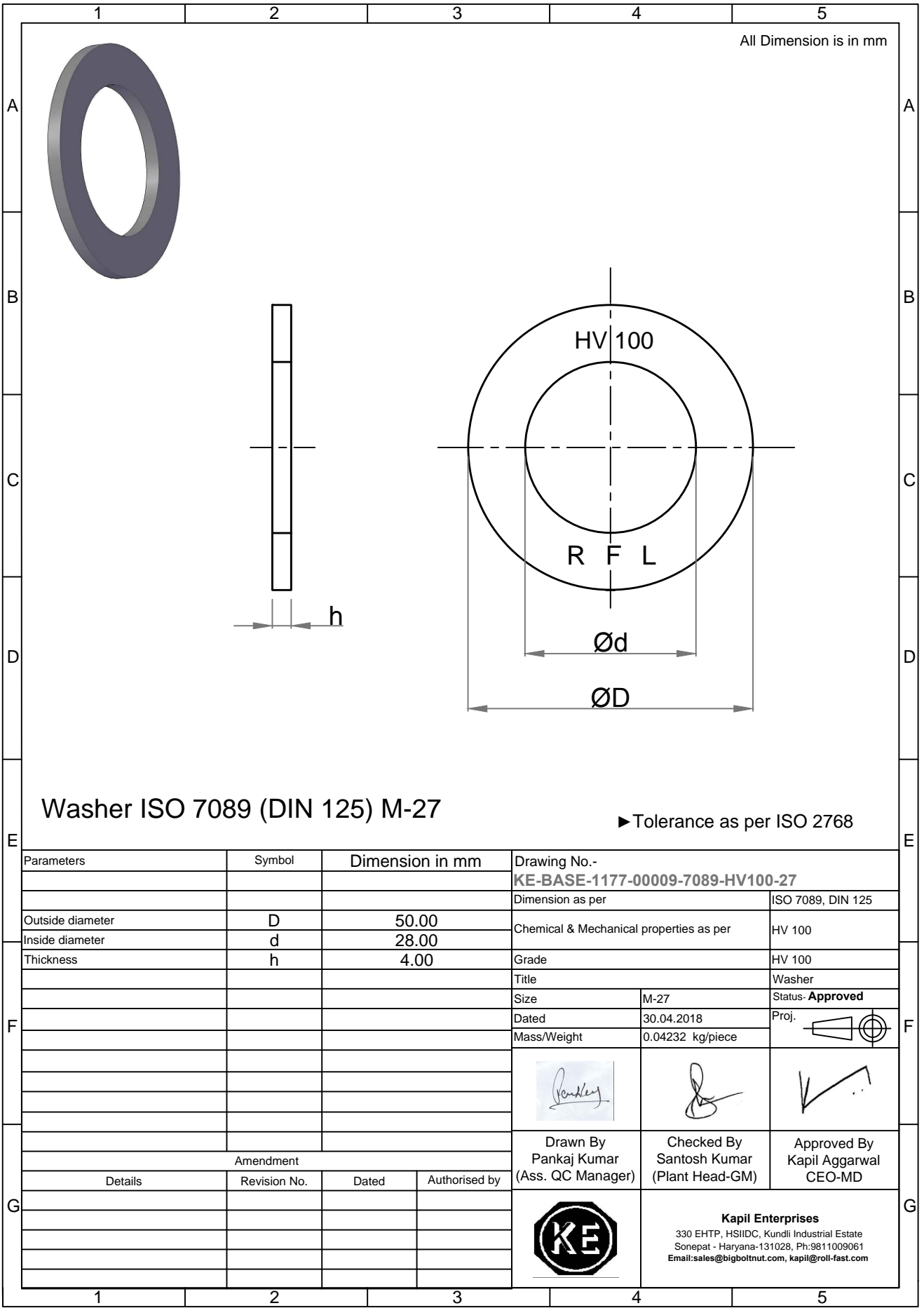

All Dimension is in mm

Washer ISO 7089 (DIN 125) M-27

► Tolerance as per ISO 2768

Parameters		Symbol	Dimension in mm	Drawing No.- KE-BASE-1177-00009-7089-HV100-27	
				Dimension as per	ISO 7089, DIN 125
Outside diameter		D	50.00	Chemical & Mechanical properties as per	HV 100
Inside diameter		d	28.00	Grade	HV 100
Thickness		h	4.00	Title	Washer
				Size	M-27
				Dated	30.04.2018
				Mass/Weight	0.04232 kg/piece
				Proj.	
				Drawn By Pankaj Kumar (Ass. QC Manager)	Checked By Santosh Kumar (Plant Head-GM)
				Approved By Kapil Aggarwal CEO-MD	
Amendment				<p>Kapil Enterprises 330 EHTP, HSIIDC, Kundli Industrial Estate Sonepat - Haryana-131028, Ph:9811009061 Email:sales@bigboltnut.com, kapil@roll-fast.com</p>	
Details	Revision No.	Dated	Authorised by		