

Note: This Drawing is the property of Kapil Enterprises-Kundli, and must not be copied or reproduced without permission or Written authorisation by Kapil Enterprises-Kundli

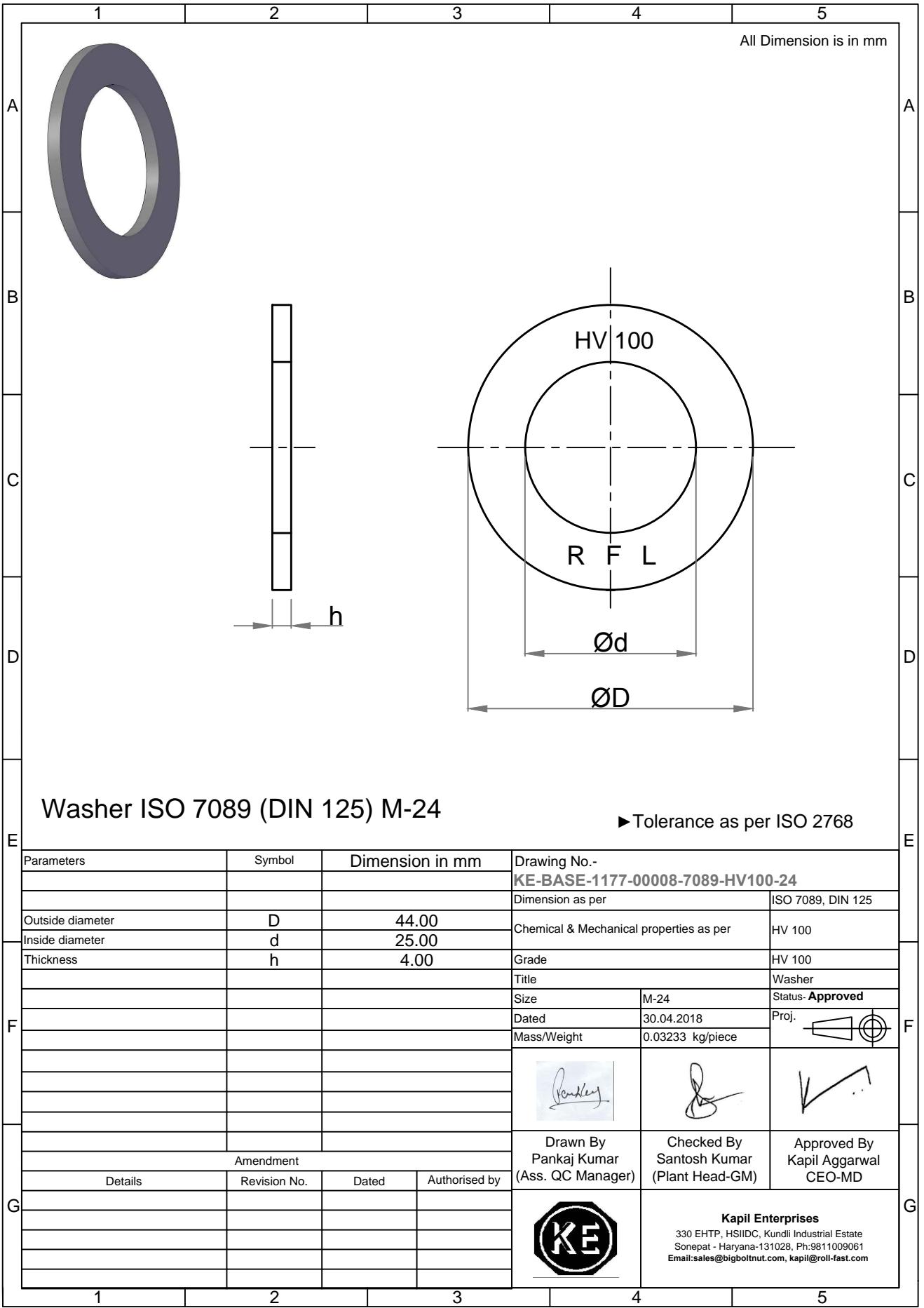

All Dimension is in mm

Washer ISO 7089 (DIN 125) M-24

► Tolerance as per ISO 2768

Parameters	Symbol	Dimension in mm
Outside diameter	D	44.00
Inside diameter	d	25.00
Thickness	h	4.00
Amendment		
Details	Revision No.	Dated
		Authorised by

Drawing No.- KE-BASE-1177-00008-7089-HV100-24	
Dimension as per	ISO 7089, DIN 125
Chemical & Mechanical properties as per	HV 100
Grade	HV 100
Title	Washer
Size	M-24
Dated	30.04.2018
Mass/Weight	0.03233 kg/piece
Proj.	
Drawn By Pankaj Kumar (Ass. QC Manager)	Checked By Santosh Kumar (Plant Head-GM)
Approved By Kapil Aggarwal CEO-MD	
Kapil Enterprises 330 EHTP, HSIIDC, Kundli Industrial Estate Sonapat - Haryana-131028, Ph:9811009061 Email:sales@bigboltnut.com, kapil@roll-fast.com	